

HeatReg Smart 3.0









220-240V, 50/60Hz, 13A 3000W, Ta -25°C - +35°C, To +5°C - +35°C, Operating Frequency: 2402-2480MHz, Maximum Radio Frequency Output Power: 10dBm



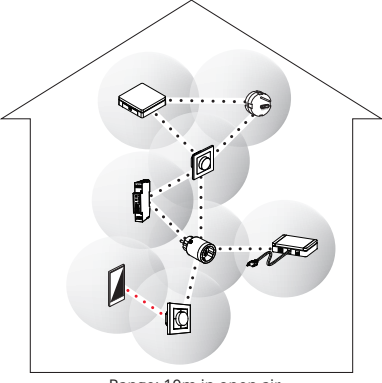

SG Smart

GET IT ON
Google Play

Download on the
App Store



Range: 10m in open air

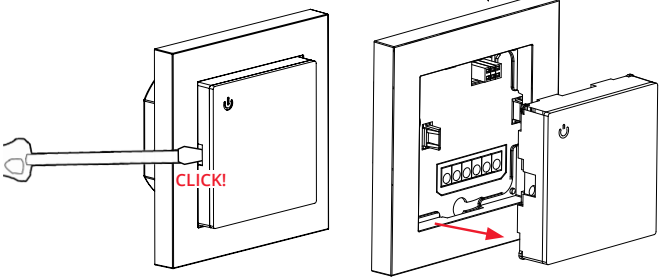

CLICK!

0,5 - 2.5 mm² 6mm

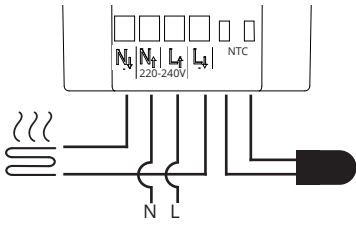

N L

300cm

- SG 12kΩ
- CTM 47kΩ
- Devi 15kΩ
- Elko 10kΩ
- Ebeco 10kΩ
- MicroMatic 12kΩ
- OJ 12kΩ
- Schneider 10kΩ

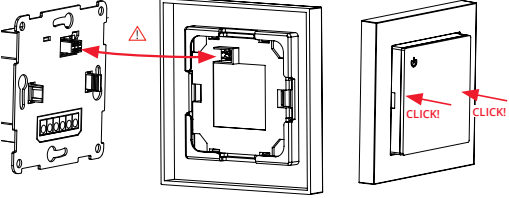

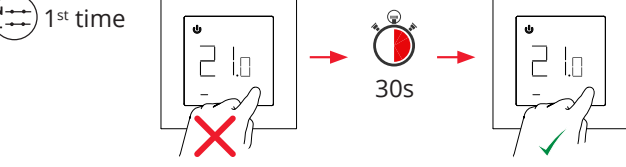

CLICK! CLICK!

1st time

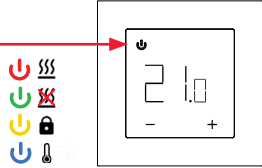

30s

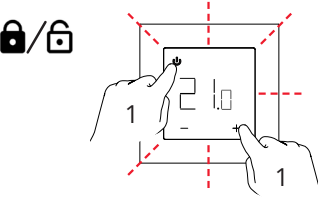
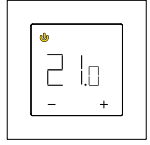

NO: Kan kun installeres og vedlikeholdes av en registrert installasjonsvirksomhet.
DK: Må kun installeres og vedlikeholdes af uddannet elektriker.
SE: Skall installeras och underhållas av behörig elektriker.
EN: Only to be installed and maintained by an authorized electrician.
FR: Doit être installé et maintenu par un électricien qualifié.
NL: Mag alleen geïnstalleerd en onderhouden worden door een bevoegde electricien.
DE: Dieses Produkt darf nur durch autorisiertes Personal (z.B. Elektro-Installateur) angeschlossen, in Betrieb genommen und gewartet werden.
FI: Asentaa ja huoltaa saa vain valtuutettu sähköasentaja

NO: Skru av strømmen før montering.
DK: Sluk for strømmen inden montering.
SE: Stäng av strömmen innan montering.
EN: Turn off power before installation.
FR: Couper le courant avant l'installation.
NL: Stroom uitschakelen voor u het toestel installeert.
DE: Vor Installationsarbeiten den Strom abschalten.
FI: Sammuta virta ennen kytkemistä

NORWAY
 SG Armaturen AS
 Skytterheia 25
 N-4790 Lillesand

SWEDEN
 SG Armaturen AB
 Tel: +46 31 81 71 10
 info@sg-ab.se
 www.sg-ab.se

GERMANY
 SG Leuchten GmbH
 Tel: +49 40 23 99 44 59
 info@sg-leuchten.de
 www.sg-leuchten.de

FRANCE
 SG Lighting SA/NV
 Tel: +33(0) 4 94 93 00 00
 info.france@sglighting.fr
 www.sglighting.net

SWITZERLAND
 SG Leuchten SA
 Tel: + +41 44 868 20 00
 info@sg-leuchten.ch
 www.sg-leuchten.ch

Tel: +47 37 50 03 00
 firmapost@sg-as.no
 www.sg-as.no

DENMARK
 SG Armaturen A/S
 Tel: +45 70 70 72 13
 info@sg-as.dk
 www.sg-as.dk

FINLAND
 SG Armaturen Oy
 Tel: +358 02 07 30 39 60
 info@sg-oy.fi
 www.sg-oy.fi

BENELUX
 SG Lighting SA/NV
 Tel: +32(0) 15 20 72 71
 info.benelux@sglighting.net
 www.sglighting.net

INTERNATIONAL
 SG Lighting Co Ltd.
 Tel: +86 769 88 49 20 88
 cindy@sgdgcn.com
 www.sg-as.com

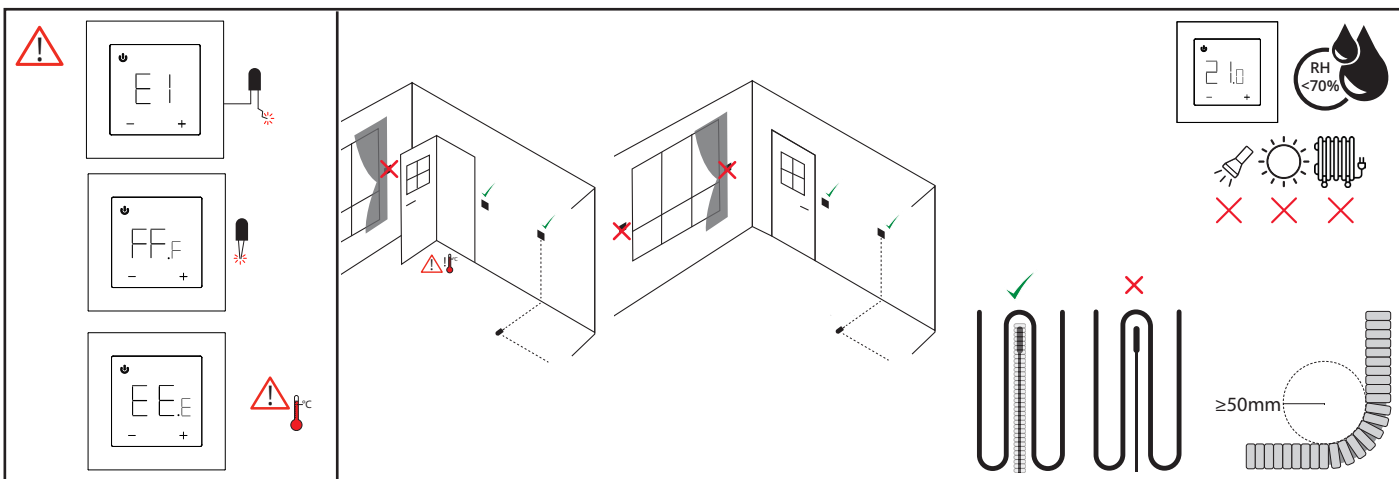

Pairing

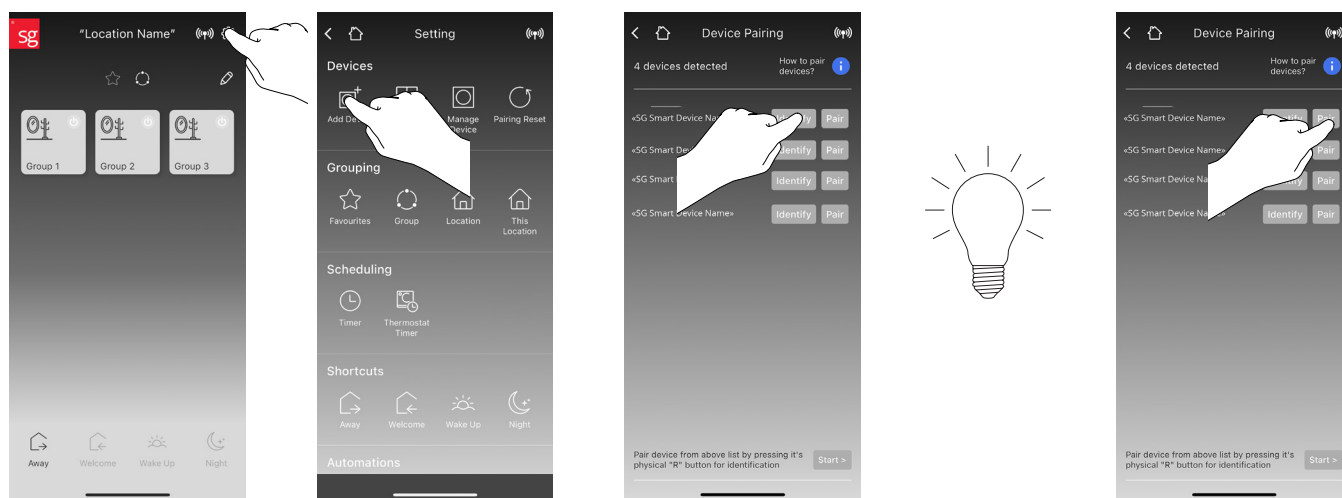

Settings

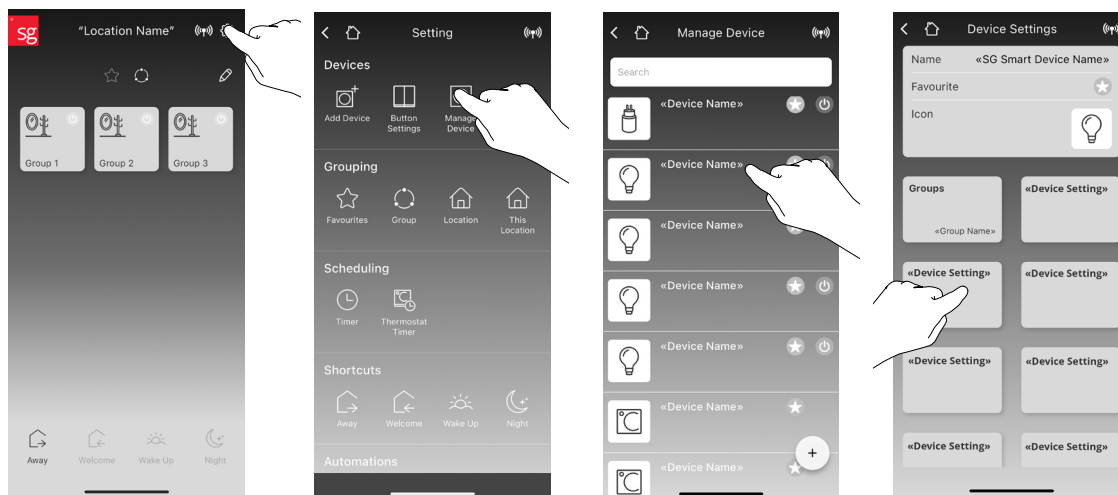

Supports modes:
 • Temperature controlled
 • Power controlled

Thermostat Timer

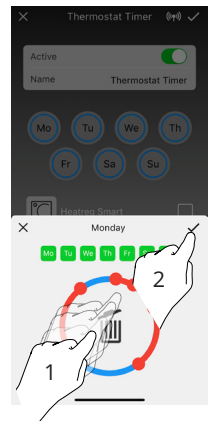
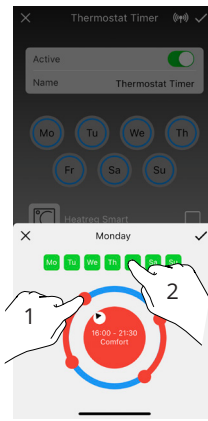
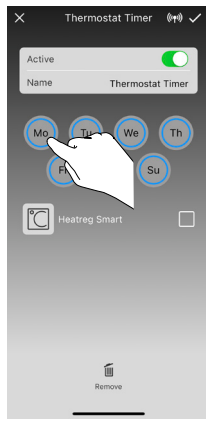
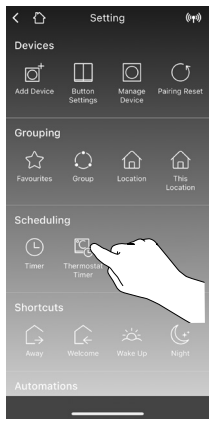

Delete time frame.
Pull point into middle.

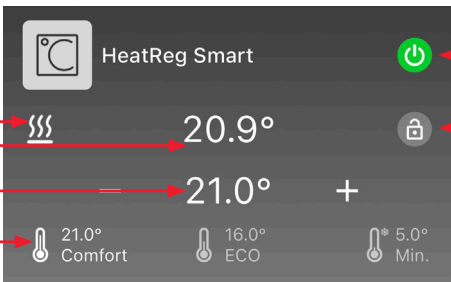
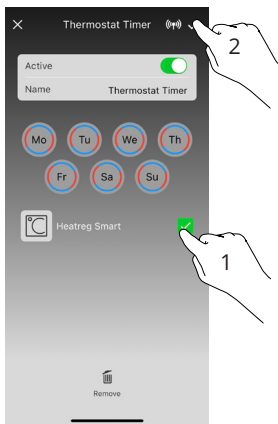

1:
NO: Ønsket temperatur
DK: Ønsket temperatur
SE: Önskad temperatur
EN: Threshold regulation
FR: Température souhaitée
NL: Gewenste temperatuur
DE: Gewünschte Temperatur
FI: Haluttu lämpötila

2:
NO: Termostat av/på
DK: Tænd/sluk termostat
SE: På/av termostat
EN: ON/OFF thermostat
FR: Thermostat marche / arrêt
NL: Aan / uit thermostaat
DE: Ein / Aus-Thermostat
FI: On/off termostaatti

3:
NO: Nåværende temperatur
DK: Nuværende temperatur
SE: Aktuell temperatur
EN: Current temperature
FR: Température actuelle
NL: Huidige temperatuur
DE: Aktuelle Temperatur
FI: Nykyinen lämpötila

4:
NO: Forhåndsinnstilt nivå
DK: Forudindstillet niveauer
SE: Förinställda nivåer
EN: Predefined thresholds
FR: Niveaux pré-réglés
NL: Vooraf ingestelde niveaus
DE: Voreingestellte Ebenen
FI: Esiasetetut tasot

5:
NO: Åpent vindu/ varme
DK: Åbn vindue/kalder på varme
SE: Öppet fönster/ uppvärmning
EN: Open window/heating
FR: Fenêtre ouverte/ chauffage
NL: Open raam/ verwarming
DE: Fenster öffnen/ Heizung
FI: Avoin ikkuna/ lämmitys

6:
NO: Barnesikring
DK: Børnesikring
SE: Barnlås
EN: Child lock
FR: Sécurité enfant
NL: Kinderslot
DE: Kindersicherung
FI: Lapsilukko

Wood floor

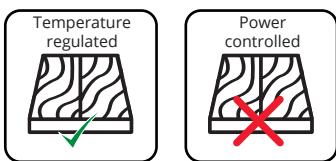

Resistive load: Max13A / 3000VA @ 230V

Inductive load: Max 1A power factor 0.3



Concrete floor

