

## CRIKIT P 24VAC 2CO L

**Weidmüller Interface GmbH & Co. KG**  
 Klingenbergstraße 26  
 D-32758 Detmold  
 Germany

www.weidmueller.com

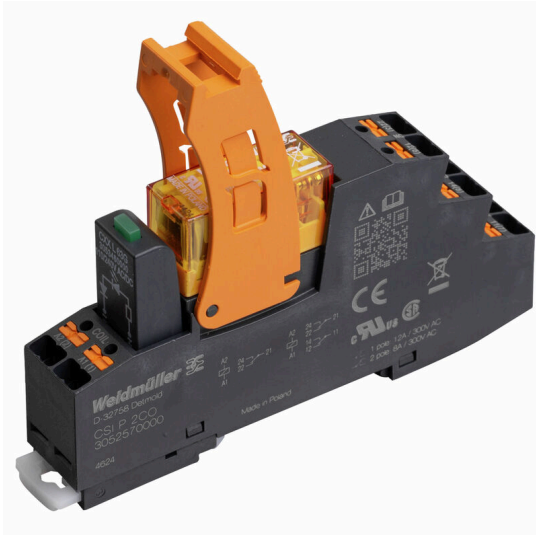

Similar to illustration

Relay sockets with PUSH IN connection for quick installation

### General ordering data

Version	CUBESERIES, Number of contacts: 2, CO contact AgNi, Rated control voltage: 24 V AC, Continuous current: 8 A, PUSH IN, Test button available: No
Order No.	<a href="#">3137400000</a>
Type	CRIKIT P 24VAC 2CO L
GTIN (EAN)	4099987361866
Qty.	10 items

**CRIKIT P 24VAC 2CO L**

**Weidmüller Interface GmbH & Co. KG**  
 Klingenbergstraße 26  
 D-32758 Detmold  
 Germany

www.weidmueller.com

**Technical data**

**Approvals**

Approvals



ROHS Conform

**Dimensions and weights**

Depth	72.5 mm	Depth (inches)	2.8543 inch
Height	97 mm	Height (inches)	3.8189 inch
Width	15.9 mm	Width (inches)	0.626 inch
Net weight	61 g		

**Temperatures**

Storage temperature	Ambient temperature	-20 °C...70 °C
Operating temperature		

**Environmental Product Compliance**

RoHS Compliance Status	Compliant without exemption
REACH SVHC	No SVHC above 0.1 wt%

**Control side**

Rated control voltage	24 V AC	Rated current AC	35.9 mA
Power rating	0.9 VA	Coil resistance	400 Ω ± 10 %
Status indicator	Green LED	Input frequency	50...60Hz
Coil voltage of the replacement relay deviating from the rated control voltage	No	Coil voltage of the replacement relay	24 V AC

**Load side**

Rated switching voltage	250 V AC	Continuous current	8 A
Max. switching frequency at rated load	0.1 Hz	Max. switching voltage, AC	250 V
Max. switching voltage, DC	250 V	AC switching capacity (resistive), max.	2000 VA
DC switching capacity (resistive), max.	192 W @ 24 V	Switch-on delay	≤ 12 ms
Switch-off delay	≤ 20 ms	Contact type	2 CO contact (AgNi)
Mechanical service life	3 x 10 <sup>7</sup> switching cycles	Min. switching power	10 mA @ 12 V, 100 mA @ 5 V

**General data**

Operating altitude	≤ 2000 m, above sea level	
Mounting rail	TS 35	
Test button available	No	
Mechanical switch position indicator	No	
Colour	black	
UL94 flammability rating component	Component	Socket
	UL94 flammability rating	V-0
	Component	Relay cover
	UL94 flammability rating	V-2

## CRIKIT P 24VAC 2CO L

**Weidmüller Interface GmbH & Co. KG**  
 Klingenbergstraße 26  
 D-32758 Detmold  
 Germany

www.weidmueller.com

## Technical data

### Insulation coordination

Surge voltage category	II	Dielectric strength for control side - load	5 kVeff / 1 min side
Dielectric strength of neighbouring contacts	2.5 kVeff / 1 Min.	Dielectric strength of open contact	1 kVeff / 1 min
Dielectric strength to mounting rail	4 kVeff / 1 Min.	Impulse withstand voltage	4 kV (1.2/50 µs)
Protection degree	IP20		

### Connection data

Wire connection method	PUSH IN	Stripping length, rated connection	8 mm
Clamping range, rated connection	1.5 mm <sup>2</sup>	Clamping range, min.	0.5 mm <sup>2</sup>
Clamping range, max.	1.5 mm <sup>2</sup>	Wire cross-section, solid, min.	0.5 mm <sup>2</sup>
Wire cross-section, solid, max.	1.5 mm <sup>2</sup>	Wire cross-section, solid, min. (AWG)	AWG 20
Wire cross-section, solid, max. (AWG)	AWG 16	Conductor cross-section, flexible, AEH (DIN 46228-1), max.	1.5 mm <sup>2</sup>
Blade size	0.6 x 3.5 mm		

### Classifications

ETIM 8.0	EC001437	ETIM 9.0	EC001437
ETIM 10.0	EC001437	ECLASS 14.0	27-37-16-01
ECLASS 15.0	27-37-16-01		

**CRKIT P 24VAC 2CO L**

**Weidmüller Interface GmbH & Co. KG**  
 Klingenbergstraße 26  
 D-32758 Detmold  
 Germany

www.weidmueller.com

**Drawings**

**Wiring diagram**

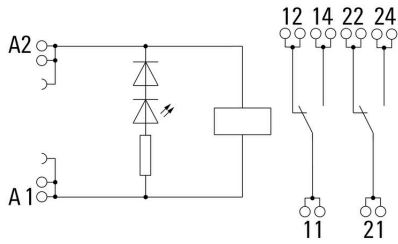

**Graph**



**Graph**



**Graph**

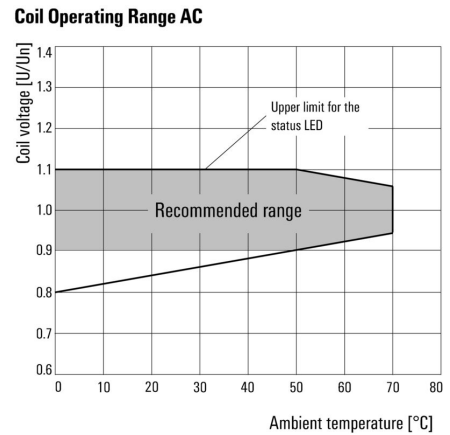

**Dimensional drawing**

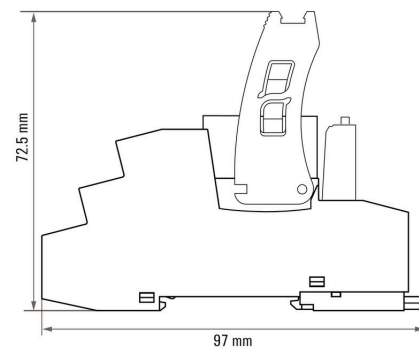



## CRIKIT P 24VAC 2CO L

**Weidmüller Interface GmbH & Co. KG**

Klingenbergstraße 26  
D-32758 Detmold  
Germany

www.weidmueller.com

## Accessories

### Slotted screwdriver

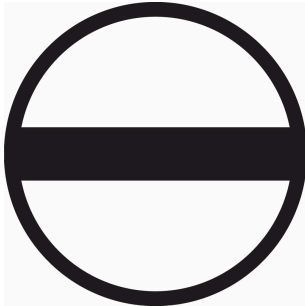

VDE insulated slot-head screwdriver, SDI DIN 7437, ISO 2380/2, drive output acc. to DIN 5264, ISO 2380/1.  
SoftFinish grip

### General ordering data

Type	SDIS 0.6X3.5X100	Version	
Order No.	<a href="#">2749810000</a>	Screwdriver, Blade width (B): 3.5 mm, Blade length: 100 mm, Blade thickness (A): 0.6 mm	
GTIN (EAN)	4050118897012		
Qty.	1 ST		

### Blank

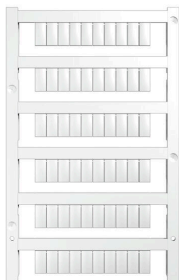

MultiFit is the Weidmüller marker system used for other makes of terminals. Similar to the Weidmüller Dekafix, the markers of the MultiFit family are available ready-for-use with standard printing.

We recommend to carry out a test with sample markers on the terminals used when using MultiFit for the first time.

- One marker, suitable for different makes of terminals.
- Ready-to-use markers with standard printing
- Blank markers for printing with the PrintJet CONNECT or Plotter
- Delivery of individually printed markers according to customer CAE data or specifications
- One marking system for all applications

For custom printing: Please send us a file of our labeling software M-Print PRO or M-Print PRO Online (without installation) for your labeling specifications.

### General ordering data

Type	MF 10/10 MC NE WS	Version	
Order No.	<a href="#">1856760000</a>	MultiFit, Terminal marker, 10 x 10 mm, Pitch in mm (P): 10.00	
GTIN (EAN)	4032248401031	Phoenix, Entelec, white	
Qty.	200 ST		
Type	MF 10/5 MC NE WS	Version	
Order No.	<a href="#">1677160000</a>	MultiFit, Terminal marker, 10 x 5 mm, Pitch in mm (P): 5.00 Phoenix,	
GTIN (EAN)	4008190475505	Wieland, Legrand, Telemecanique, Entelec, white	
Qty.	600 ST		
Type	MF 10/6 MC NE WS	Version	
Order No.	<a href="#">1677220000</a>	MultiFit, Terminal marker, 10 x 6 mm, Pitch in mm (P): 6.00 Phoenix,	
GTIN (EAN)	4008190475529	Wieland, Legrand, Telemecanique, Entelec, white	
Qty.	600 ST		
Type	MF 10/8 MC NE WS	Version	
Order No.	<a href="#">1868440000</a>	MultiFit, Terminal marker, 10 x 8 mm, Pitch in mm (P): 8.00 Phoenix,	
GTIN (EAN)	4032248440023	Entelec, white	
Qty.	350 ST		

## CRIKIT P 24VAC 2CO L

**Weidmüller Interface GmbH & Co. KG**  
 Klingenbergstraße 26  
 D-32758 Detmold  
 Germany

www.weidmueller.com

## Accessories

### MultiFit



#### MultiMark MultiFit

For connectors from competitors.

The elastic surface finish makes for simple installation. This special material enables the strips to be stretched to accommodate slight variations in spacing, especially with long terminal blocks.

A print resolution of 300 dpi also produces a very legible script. Your benefits with MultiMark

- Firm hold and durable printing
- Continuous strips save installation time
- Easy mounting thanks to an innovative composite material
- Large label field for optimal legibility
- High flexibility thanks to manufacturer independence
- Firm hold and durable printing
- Continuous strips save installation time
- Easy mounting thanks to an innovative composite material
- Large label field for optimal legibility
- High flexibility thanks to manufacturer independence
- ] • Firm hold and durable printing
- Continuous strips save installation time
- Easy mounting thanks to an innovative composite material
- Large label field for optimal legibility
- High flexibility thanks to manufacturer independence

### General ordering data

Type	MF 10/10 MM WS	Version
Order No.	<a href="#">2886000000</a>	Terminal marker, 10 x 10 mm, white
GTIN (EAN)	4064675854609	
Qty.	300 ST	
Type	MF 10/12 MM WS	Version
Order No.	<a href="#">2886010000</a>	Terminal marker, 10 x 12 mm, white
GTIN (EAN)	4064675854616	
Qty.	250 ST	
Type	MF 10/3.5 MM WS	Version
Order No.	<a href="#">2885970000</a>	Terminal marker, 10 x 3.5 mm, Pitch in mm (P): 3.50 white
GTIN (EAN)	4064675854579	
Qty.	850 ST	
Type	MF 10/4.2 MM WS	Version
Order No.	<a href="#">2885980000</a>	Terminal marker, 10 x 4.2 mm, Pitch in mm (P): 4.20 white
GTIN (EAN)	4064675854586	
Qty.	750 ST	
Type	MF 10/5 MM WS	Version
Order No.	<a href="#">2519170000</a>	Terminal marker, 10 x 5 mm, white
GTIN (EAN)	4050118531190	
Qty.	600 ST	
Type	MF 10/6 MM WS	Version
Order No.	<a href="#">2519180000</a>	Terminal marker, 10 x 6 mm, white
GTIN (EAN)	4050118531404	
Qty.	500 ST	

## CRIKIT P 24VAC 2CO L

**Weidmüller Interface GmbH & Co. KG**  
 Klingenbergstraße 26  
 D-32758 Detmold  
 Germany

[www.weidmueller.com](http://www.weidmueller.com)

## Accessories

Type	MF 10/7.6 MM WS	Version
Order No.	<a href="#">2885990000</a>	Terminal marker, 10 x 7.6 mm, Pitch in mm (P): 7.60 white
GTIN (EAN)	4064675854593	
Qty.	400 ST	
Type	MF 10/8 MM WS	Version
Order No.	<a href="#">2519190000</a>	Terminal marker, 10 x 8 mm, white
GTIN (EAN)	4050118531411	
Qty.	400 ST	

## Accessories

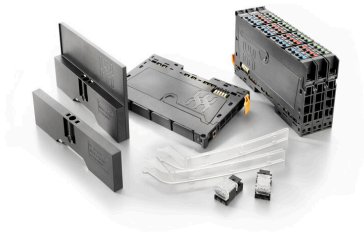

### System accessory

Discover a wide range of accessories for your u-remote system - the ideal addition to make your applications even more efficient and flexible.

## General ordering data

Type	UR20-EBK-ACC	Version
Order No.	<a href="#">1346610000</a>	End bracket, ,
GTIN (EAN)	4050118151596	
Qty.	5 ST	