

Tysnes 66 Sensor

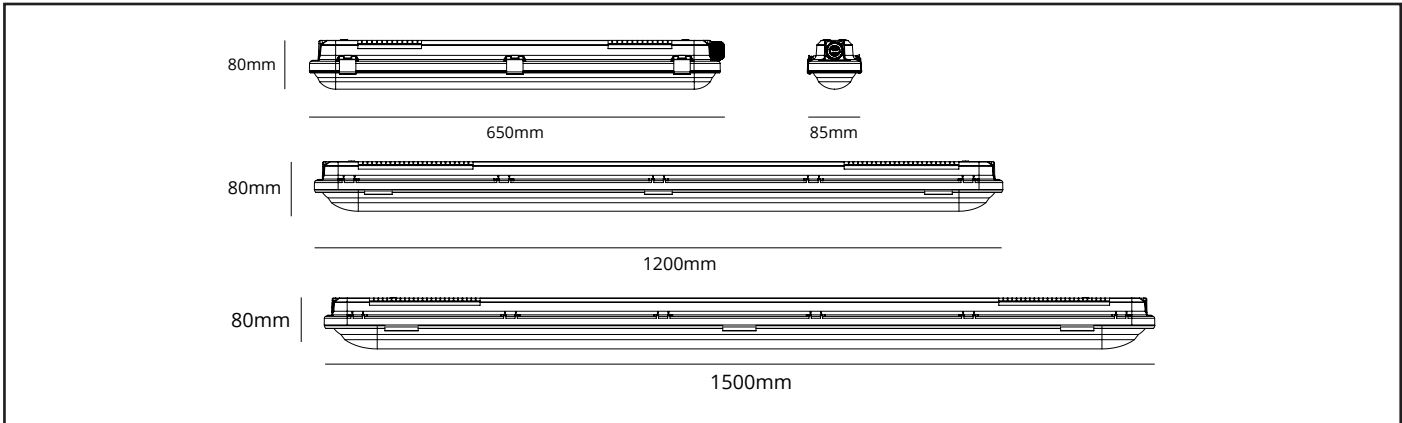

IP66 IK08

220-240V, 50/60Hz



Alt A

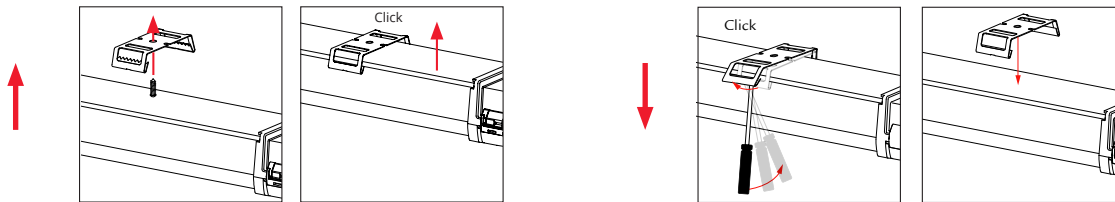
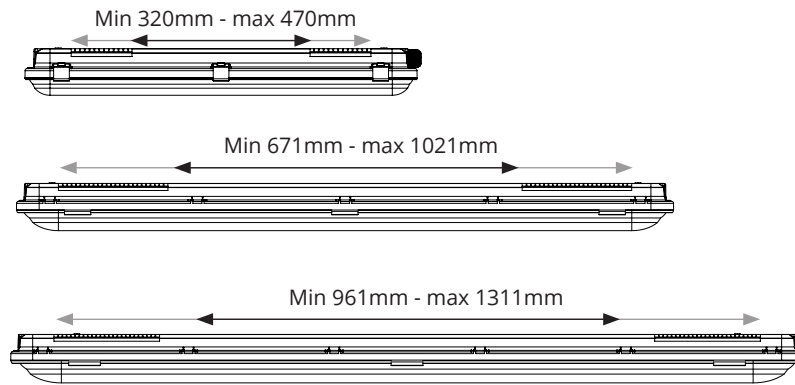
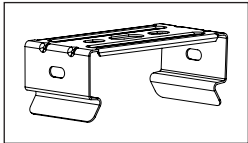

Alt B

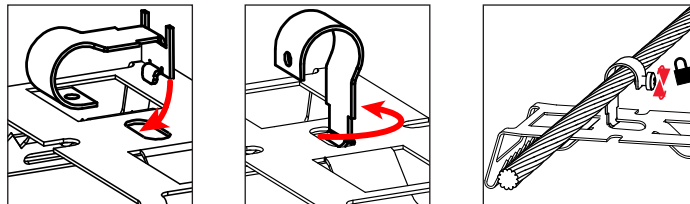
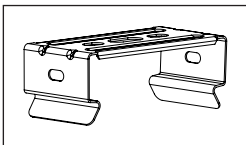

NORWAY
SG Armaturen AS

Skytterheia 25
N-4790 Lillesand

Tel: +47 37 50 03 00
firmapost@sg-as.no
www.sg-as.no

SWEDEN

SG Armaturen AB
Tel: +46 31 81 71 10
info@sg-ab.se
www.sg-ab.se

FINLAND

SG Armaturen Oy
Tel: +358 02 07 30 39 60
info@sg-oy.fi
www.sg-oy.fi

DENMARK

SG Armaturen A/S
Tel: +45 70 70 72 13
info@sg-as.dk
www.sg-as.dk

UNITED KINGDOM

SG Lighting LTD
Tel: +47 37 50 03 00
info@sglighting.co.uk
www.sglighting.co.uk

FRANCE

SG Lighting SA/NV
Tel: +33(0) 4 94 93 00 00
info.france@sglighting.fr
www.sglighting.net

BENELUX

SG Lighting SA/NV
Tel: +32(0) 15 20 72 71
info.benelux@sglighting.net
www.sglighting.net

GERMANY

SG Leuchten GmbH
Tel: +49 40 23 99 44 59
info@sg-leuchten.de
www.sg-leuchten.de

INTERNATIONAL

SG Lighting Co Ltd.
Tel: +86 769 88 49 20 88
cindy@sgdgc.com
www.sg-as.com

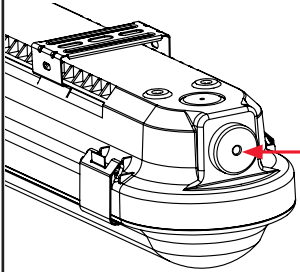
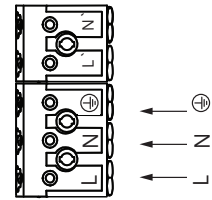
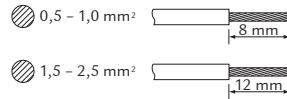
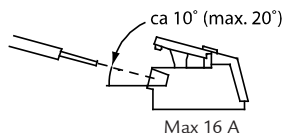

TET 7-13

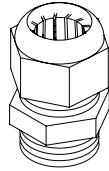

PG 13,5/M20,
not included



Product name	Max number of luminaires C16
1200 DALI	40
1500 DALI	34
1200 On/Off	36
1500 On/Off	36
Sensor 1200	36
Sensor 1500	36

Dipswitch

Tysnes 66 650:

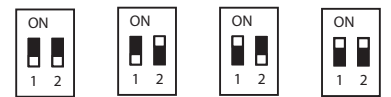

	200	250	300	350
mA	200	250	300	350
lm	57%	71%	86%	100%

Tysnes 66 1200:

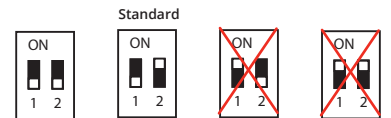

	800	900	975	1050
mA	800	900	975	1050
lm	89%	100%	-	-



Tysnes 66 1500:

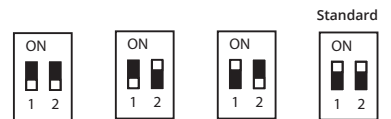

	800	900	975	1050
mA	800	900	975	1050
lm	76%	86%	93%	100%

2: Replaceable (LED only) light source by a professional

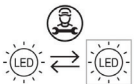

3: Replaceable control gear by a professional



NO: Kan kun installeres og vedlikeholdes av en registrert installasjonsvirksomhet.

DK: Må kun installeres og vedligeholdes af uddannet elektriker.

SE: Skall installeras och underhållas av behörig elektriker.

EN: Only to be installed and maintained by an authorized electrician.

FR: Doit être installé et maintenu par un électricien qualifié.

NL: Mag alleen geïnstalleerd en onderhouden worden door een bevoegde elektricien.

DE: Dieses Produkt darf nur durch autorisiertes Personal (z.B. Elektro-Installateur) angeschlossen, in Betrieb genommen und gewartet werden.

FI: Asentaa ja huoltaa saa vain valtuutettu sähköasentaja

NO: Skru av strømmen før montering.

DK: Sluk for strømmen inden montering.

SE: Stäng av strømmen innan montering.

EN: Turn off power before installing.

FR: Couper le courant avant l'installation.

NL: Stroom uitschakelen voor u het toestel installeert.

DE: Vor Installationsarbeiten den Strom abschalten.

FI: Sammuta virta ennen kytkemistä

NO: Til bruk i miljøer der ansamling av ledende støv på armaturen er forventet

DK: Til brug i miljøer, hvor der må forventes en akkumulering af ledende støv på armaturet.

SE: För användning i miljöer där ackumulering av ledande damm på armaturen förväntas.

EN: For use in environments where an accumulation of conductive dust on the luminaire may be expected

FR: Pour une utilisation dans les environnements où de la poussière conductrice peut se déposer sur le luminaire

NL: Voor gebruik in omgevingen waar een opeenhoping van stof op de armaturen kan worden verwacht

DE: Diese Leuchten sind auch für Umgebungen geeignet, in denen leitfähiger Staub vorhanden sein kann

FI: Valaisimet soveltuvat hyvin pölyisiin tiloihin palovaaran välttämiseksi

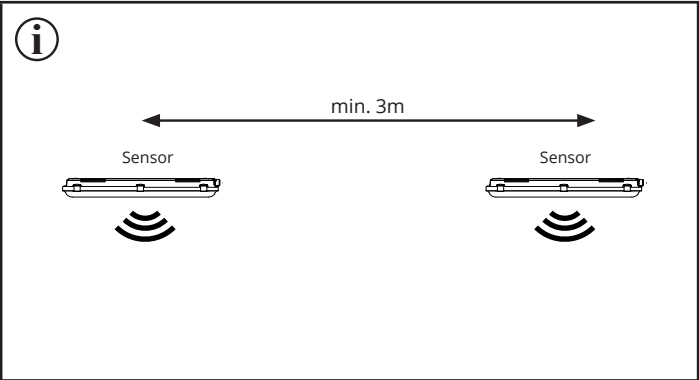
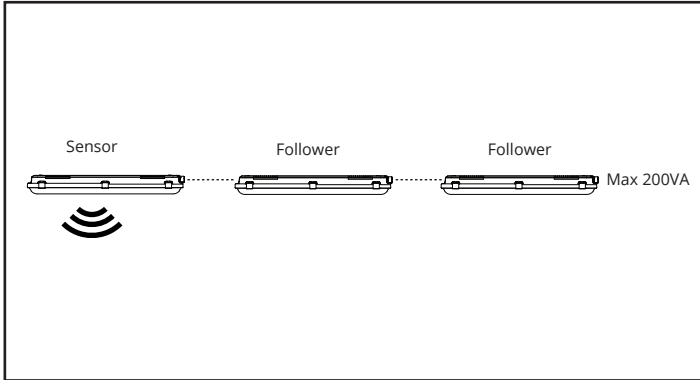

!

NO: Max antall armaturer er begrenset av sikringen
DK: Det maksimale antal armaturer er begrænset af afbryderen
SE: Max antal armaturer begränsas av säkringen.
EN: Max number of fixtures is limited by the circuit breaker
FR: Le nombre maximum de montages est limité par le disjoncteur
NL: Max. aantal armaturen beperkt door de stroomonderbreker
DE: Die maximale Anzahl der Geräte ist abhängig vom eingesetzten Leitungsschutzschalter
FI: Valaisinten maksimimäärä määräytyy sulakkeen koon mukaan

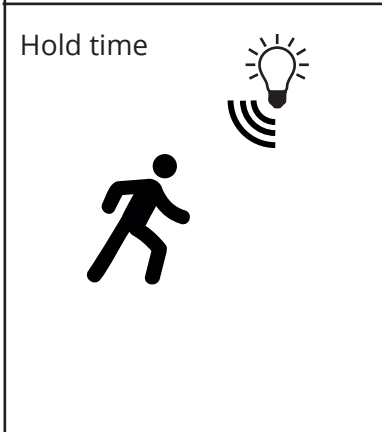
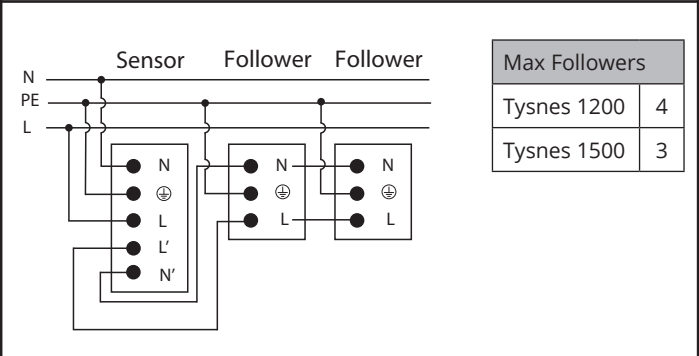

	3	4	5	
5 sec	1	1	1	Standard
30 sec	0	1	1	
90 sec	1	0	1	
5 min	0	0	1	
20 min	1	1	0	
30 min	0	0	0	

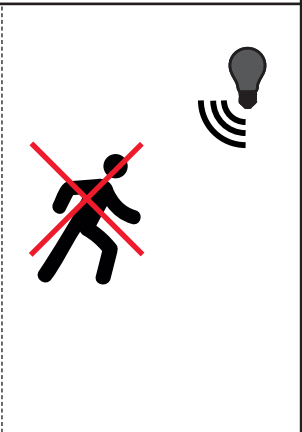

Motion sensitivity

	1	2	
100%	1	1	Standard
75%	0	1	
50%	1	0	
25%	0	0	

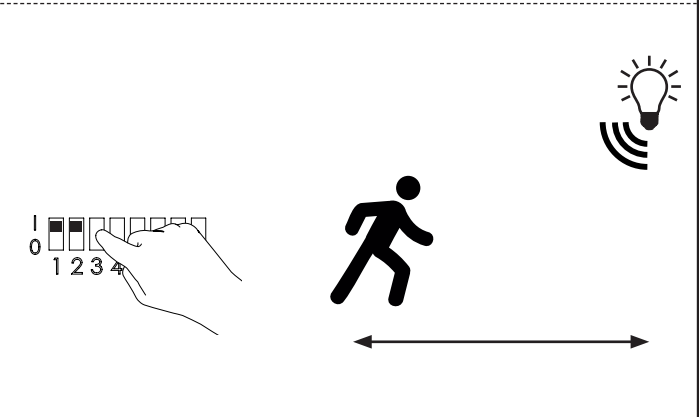
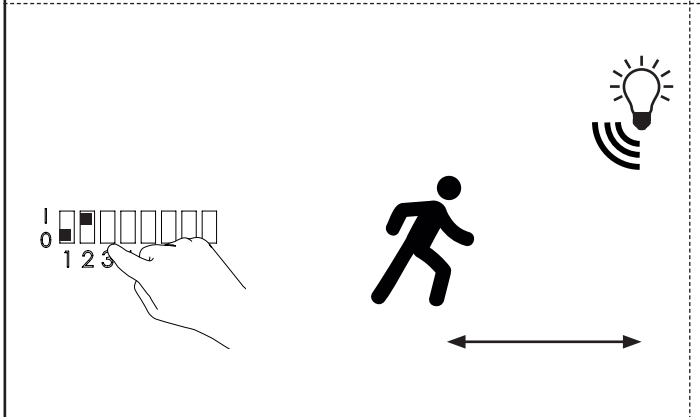
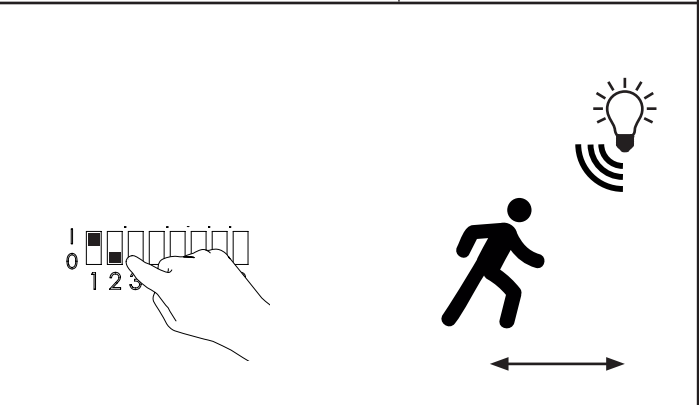

Daylight sensitivity

	6	7	8
Low	1	1	1
Medium	1	1	0
Medium +	0	1	0
High	1	0	0
Off	0	0	0

Standard

