



# Sense 3000lm Driver Kit DALI



700mA CC (Constant current), SELV

Sense Driver Kit:

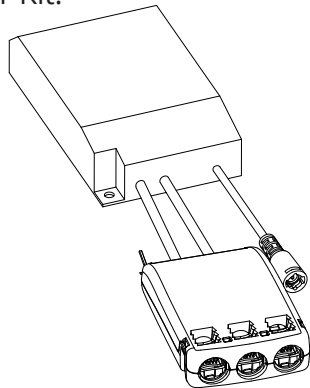

Sense Panel:

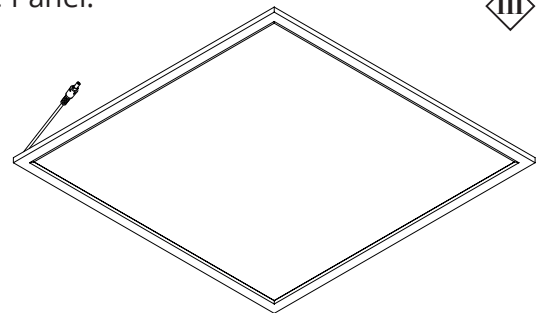

(Sold separately)

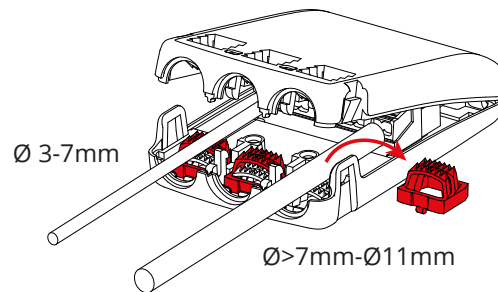
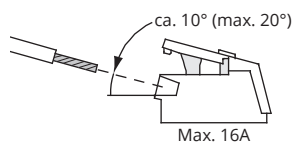
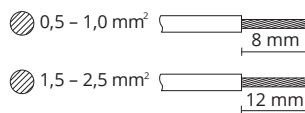

Push Dim

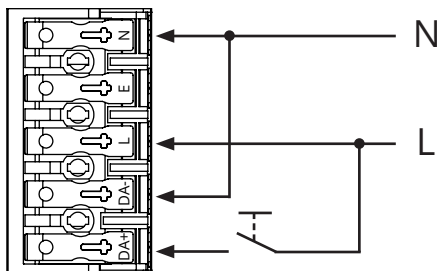

DALI Dim

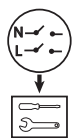
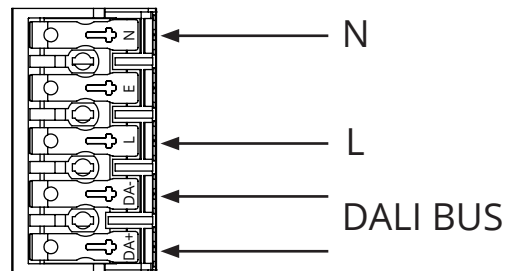

**NO:** Skru av strømmen før montering.  
**DK:** Sluk for strømmen inden montering.  
**SE:** Stäng av strømmen innan montering.  
**EN:** Turn off power before installing.  
**FR:** Couper le courant avant l'installation.  
**NL:** Stroom uitschakelen voor u het toestel installeert.  
**DE:** Vor Installationsarbeiten den Strom abschalten.  
**FI:** Sammuta virta ennen kytkemistä

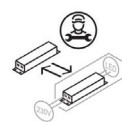

**NO:** Kan kun installeres og vedlikeholdes av en registrert installasjonsvirksomhet.  
**DK:** Må kun installeres og vedligeholdes af uddannet elektriker.  
**SE:** Skall installeras och underhållas av behörig elektriker.  
**EN:** Only to be installed and maintained by an authorized electrician.  
**FR:** Doit être installé et maintenu par un électricien qualifié.  
**NL:** Mag alleen geïnstalleerd en onderhouden worden door een bevoegde electricien.  
**DE:** Dieses Produkt darf nur durch autorisiertes Personal (z.B. Elektro-Installateur) angeschlossen, in Betrieb genommen und gewartet werden.  
**FI:** Asentaa ja huoltaa saa vain valtuutettu sähköasentaja

Rev: 28.01.2021

**NORWAY**  
 SG Armaturen AS  
 Skytterheia 25  
 N-4790 Lillesand

**SWEDEN**  
 SG Armaturen AB  
 Tel: +46 31 81 71 10  
 info@sg-ab.se  
 www.sg-ab.se

**DENMARK**  
 SG Armaturen A/S  
 Tel: +45 70 70 72 13  
 info@sg-as.dk  
 www.sg-as.dk

**FRANCE**  
 SG Lighting SA/NV  
 Tel: +33(0) 4 94 93 00 00  
 info.france@sglighting.fr  
 www.sglighting.net

**GERMANY**  
 SG Leuchten GmbH  
 Tel: +49 40 23 99 44 59  
 info@sg-leuchten.de  
 www.sg-leuchten.de

Tel: +47 37 50 03 00  
 firmapost@sg-as.no  
 www.sg-as.no

**FINLAND**  
 SG Armaturen Oy  
 Tel: +358 02 07 30 39 60  
 info@sg-oy.fi  
 www.sg-oy.fi

**UNITED KINGDOM**  
 SG Lighting LTD  
 Tel: +47 37 50 03 00  
 info@sglighting.co.uk  
 www.sglighting.co.uk

**BENELUX**  
 SG Lighting SA/NV  
 Tel: +32(0) 15 20 72 71  
 info.benelux@sglighting.net  
 www.sglighting.net

**INTERNATIONAL**  
 SG Lighting Co Ltd.  
 Tel: +86 769 88 49 20 88  
 cindy@sgdgc.com  
 www.sg-as.com

Dipswitch

	mA	lm
	300	43%
	350	50%
	400	57%
	450	64%
	500	71%
	550	79%
	600	86%
	650	93%
	<b>700</b>	<b>100%</b>
	750	107%
	800	114%
	850	121%
	900	129%
	950	136%
	1000	143%
	1050	150%

Standard

