

REL-MR- 24DC/21-21 - Enkeltrelé



2961192

EI-nr.: 4305019

<https://www.phoenixcontact.com/no/produkter/2961192>

Vær oppmerksom på at dataene som er angitt i dette PDF-dokumentet genereres fra vår onlinekatalog. Du finner komplette data i brukerdokumentasjonen. De generelle bruksvilkårene for nedlastinger fra Internett gjelder.

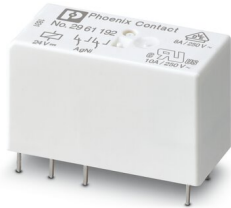

Pluggbart miniatyreffektrelé, med effektkontakt, to vekselkontakter, inngangsspenning 24 V DC

Dine fordeler

- RT III-tett (kan rengjøres)
- opptil 8 A koblingsstrøm

Forretningsinformasjon

Artikkelnummer	2961192
Pakkestørrelse	10 Stk.
Minimum bestillingsmengde	10 Stk.
Rabattgruppe	31BC61
Produkt nøkkel	CK6195
Katalogside	Side 290 (C-5-2019)
GTIN	4017918158019
Vekt pr. stk. (inkl. forpakning)	16,748 g
Vekt pr. stk. (ekskl. forpakning)	15,94 g
Tolltariffnummer	85364190
Opprinnelsesland	AT

2961192

El-nr.: 4305019

<https://www.phoenixcontact.com/no/produkter/2961192>

Tekniske spesifikasjoner

Artikkelegenskaper

Produkttype	Enkeltrelé
Driftstype	100 % ED
Levetid mekanisk	3x 10 ⁷ koblingsforløp

Isolasjonsegenskaper

Isolering	Basisisolering
-----------	----------------

Isolasjonsegenskaper

Isolering	Basisisolering
Overspenningskategori	III
Forurensningsgrad	3

Elektriske egenskaper

Levetid, elektrisk	se diagrammet
Maksimalt effekttap ved nominelle betingelser	0,41 W
Prøvespenning (Vikling/kontakt)	5 kV AC (50 Hz, 1 min.)
Prøvespenning (Kontakt/kontakt)	2,5 kV AC (50 Hz, 1 min., kontakt/kontakt)

Inngangsdata

Spoleside

Nominell inngangsspenning U_N	24 V DC
Inngangsspenningsområde	15,6 V DC ... 59,52 V DC
Drivenhetens koblingsegenskaper	monostabil
Drivenhet (polaritet)	uten polaritet
Typisk inngangsstrøm ved U_N	17 mA
Typisk reaksjonstid	7 ms
Typisk løsetid	3 ms
Spolemotstand	1440 Ω \pm 10 % (ved 20 °C)

Utgangsdata

Koble

Kontaktutførelse	2 vekselkontakter
Type koblingskontakt	Enkeltkontakt
Kontaktmaterial	AgNi
Maks. koblingsspenning	250 V AC/DC
Min. koblingsspenning	5 V (10 mA)
Varig grensestrøm	8 A
Maks. innkoblingsstrøm	25 A (20 ms)
Min. koblingsstrøm	10 mA (5 V)

REL-MR- 24DC/21-21 - Enkeltrelé



2961192

El-nr.: 4305019

<https://www.phoenixcontact.com/no/produkter/2961192>

Utkoblingseffekt (ohmsk last) maks.	192 W (24 V DC)
	96 W (48 V DC)
	60 W (ved 60 V DC)
	44 W (ved 110 V DC)
	60 W (ved 220 V DC)
	2000 VA (250 V AC)
Koblingskapasitet	2 A (24 V (DC13))
	0,2 A (250 V (DC-13))
	3 A (24 V (AC15))
	3 A (120 V (AC15))
	3 A (250 V (AC15))
Motorlast i henhold til UL 508	1/4 HP, 120 V AC
	1/2 HP, 240 V AC

Tilkoblingsdata

Tilkoblingstype	Stikk-/loddetilkobling
-----------------	------------------------

Dimensjoner

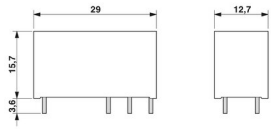
Målskisse	
Bredde	12,7 mm
Høyde	29 mm
Dybde	15,7 mm

Miljø- og levetidsbetingelser

Miljøforhold	
Beskyttelsesgrad	RT III
Omgivelsestemperatur (drift)	-40 °C ... 85 °C
Omgivelsestemperatur (lagring/transport)	-40 °C ... 85 °C

Godkjenninger

Test for skadelig gass	
Merking	ISA-S71.04. G3 Harsh Group EN 60068-2-60

Standarder og bestemmelser

Standarder/bestemmelser	IEC 60664 EN 50178 EN 61810-1
-------------------------	-------------------------------------

REL-MR- 24DC/21-21 - Enkeltrelé



2961192

El-nr.: 4305019

<https://www.phoenixcontact.com/no/produkter/2961192>

Montering

Monteringsinformasjon	kan rekkeklasseres uten avstand ($>70\text{ °C} \geq 2,5\text{ mm}$)
Innbygning	vilkårlig

2961192

El-nr.: 4305019

<https://www.phoenixcontact.com/no/produkter/2961192>

Tegninger

Diagram

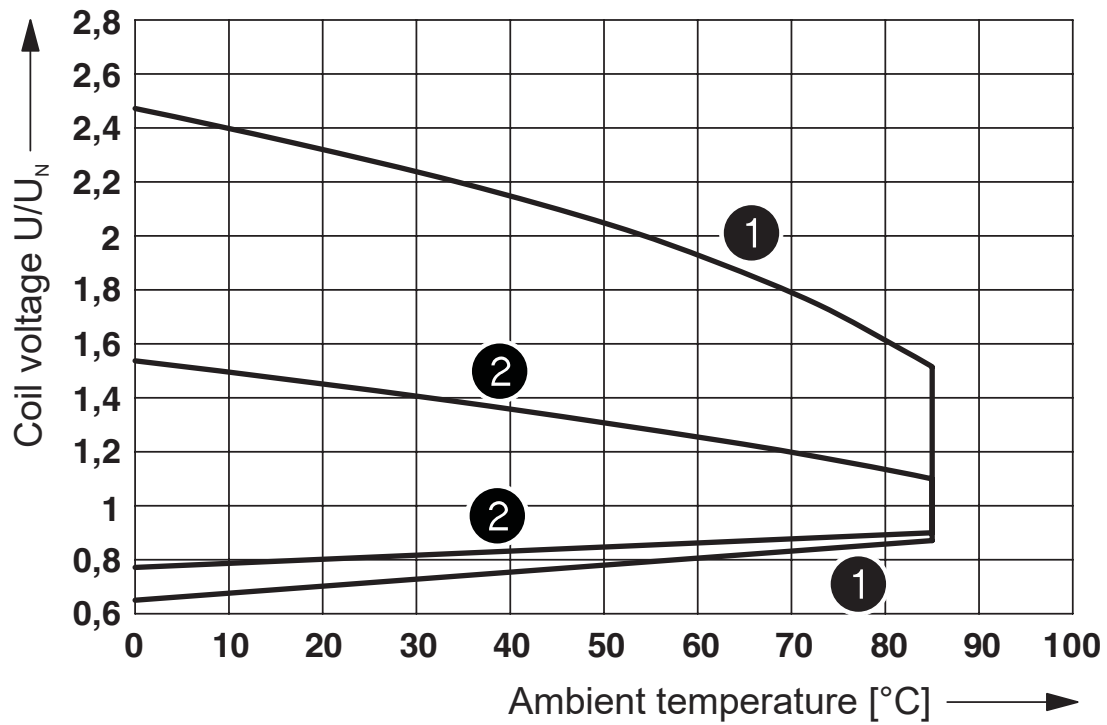

- ① DC coils
- ② AC coils

Driftspenningsområde

2961192

El-nr.: 4305019

<https://www.phoenixcontact.com/no/produkter/2961192>

Diagram

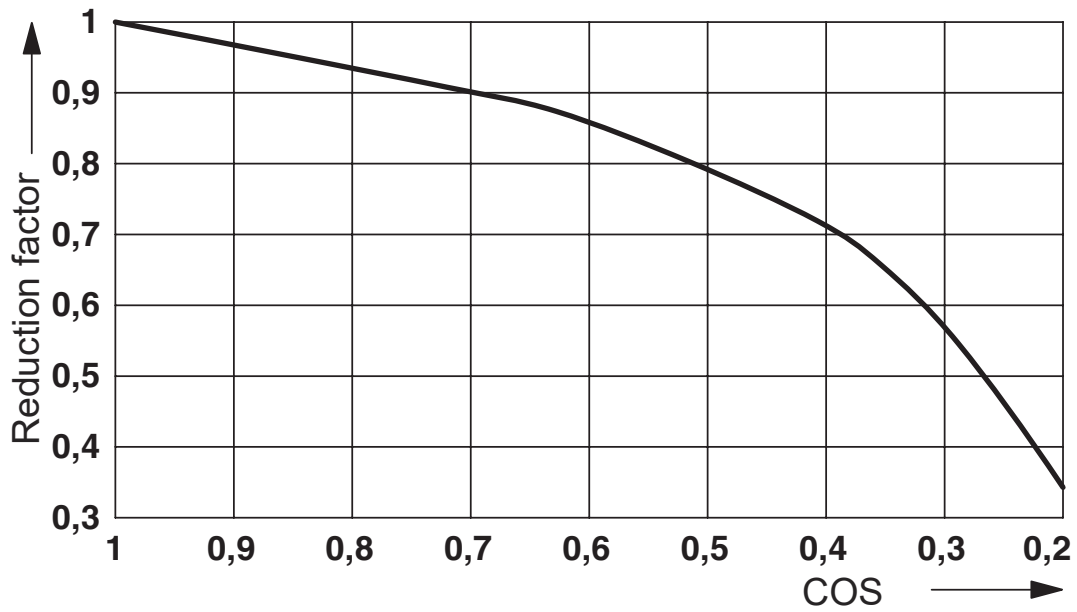

Levetid-reduksjonsfaktor

Koblingskjema

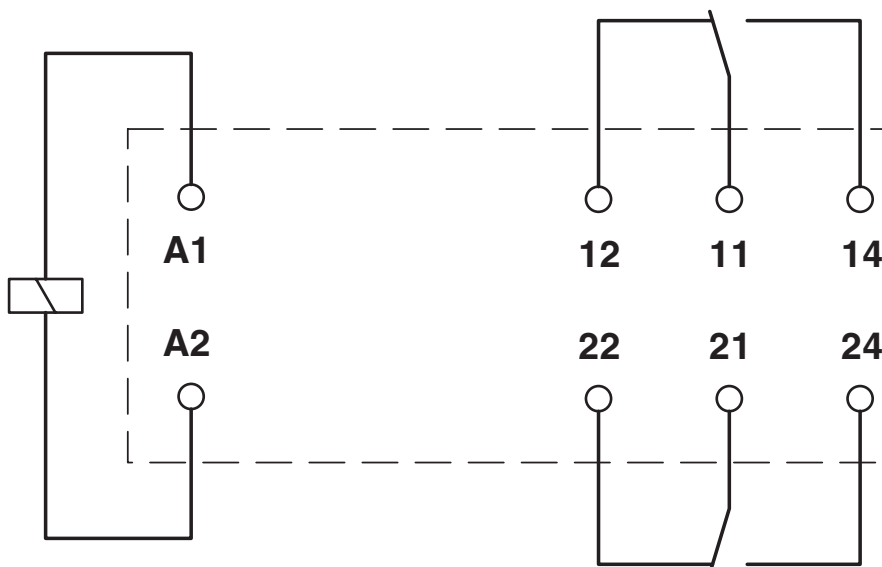

REL-MR- 24DC/21-21 - Enkeltrelé



2961192

El-nr.: 4305019

<https://www.phoenixcontact.com/no/produkter/2961192>

Boreplan/loddeputegeometri

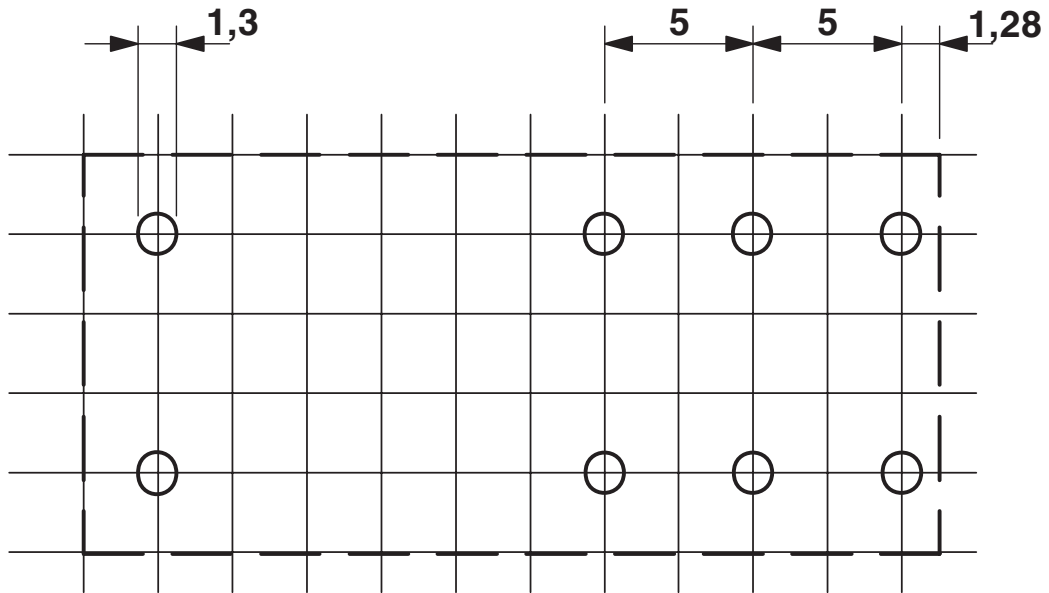

Delingsmål 2,5 mm

Målskisse

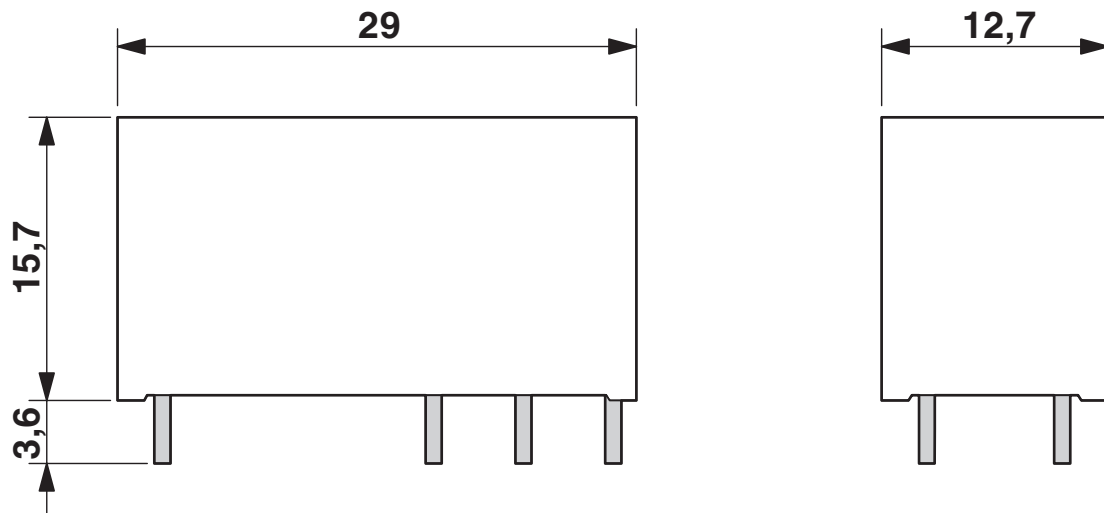

2961192

El-nr.: 4305019

<https://www.phoenixcontact.com/no/produkter/2961192>

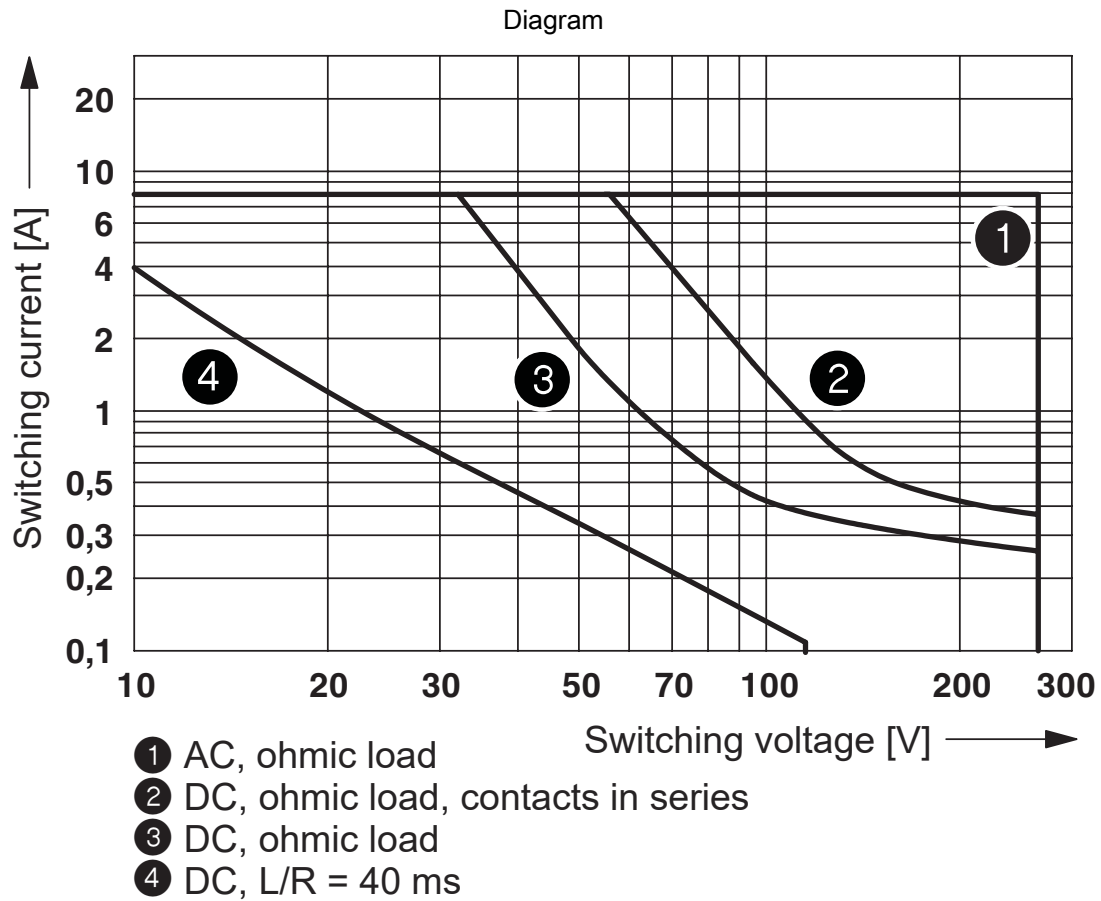

Utkoblingseffekt

2961192

El-nr.: 4305019

<https://www.phoenixcontact.com/no/produkter/2961192>

Diagram

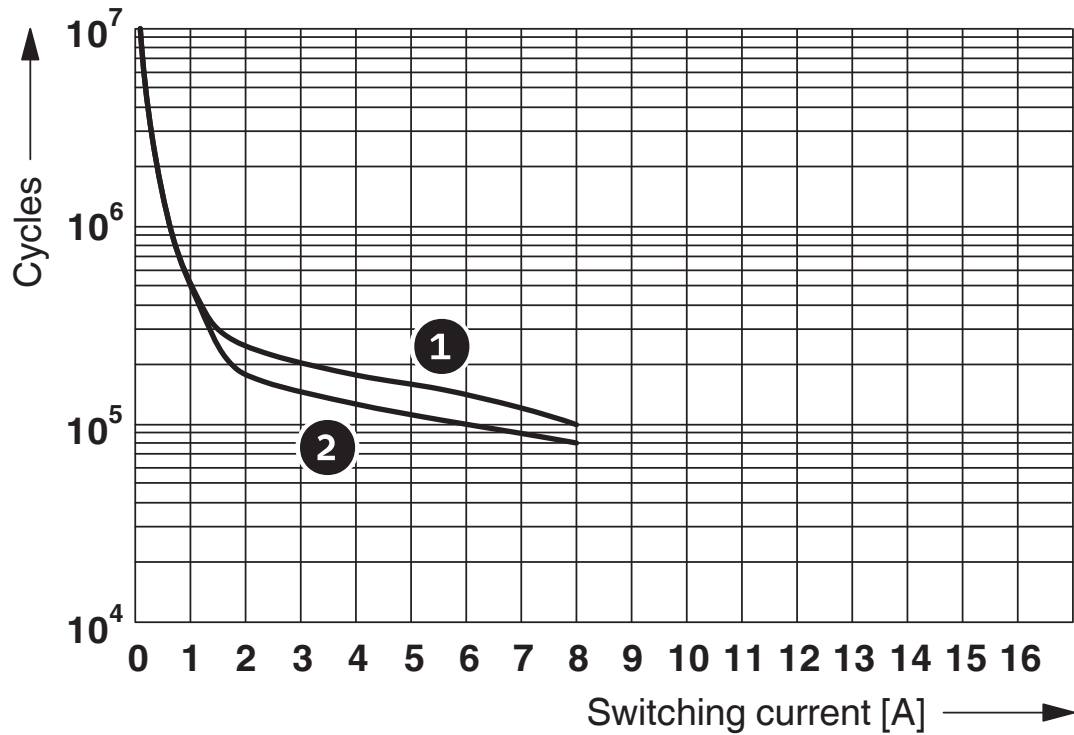

- ① 250 V AC, ohmic load (DC coils)
- ② 250 V AC, ohmic load (AC coils)

Elektrisk levetid

2961192

El-nr.: 4305019

<https://www.phoenixcontact.com/no/produkter/2961192>

Diagram

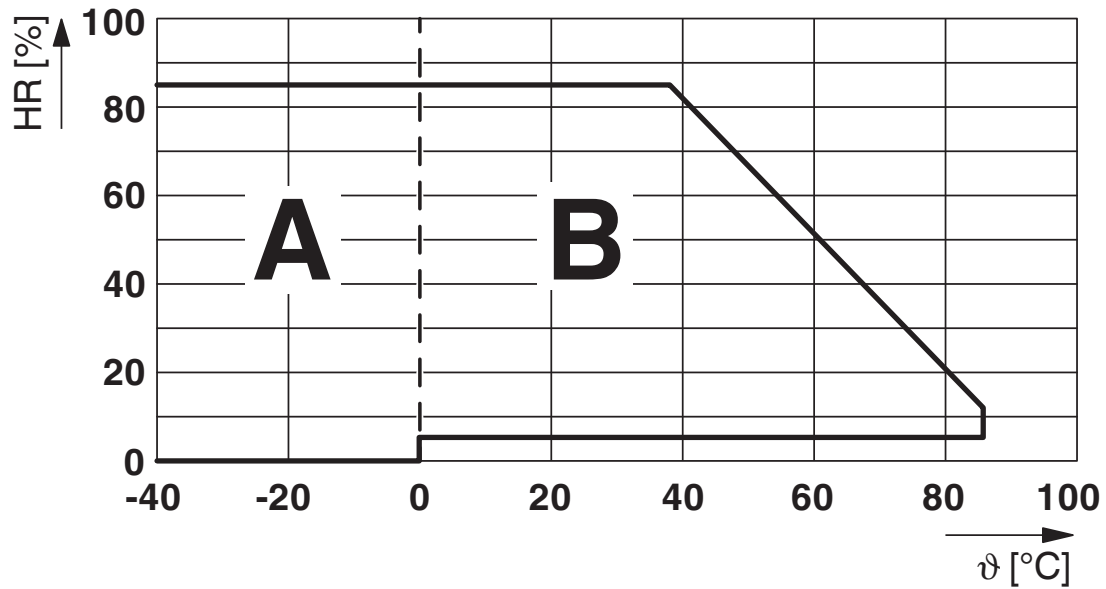

Tillatt luftfuktighet for drift og lagring.

Overhold den maksimalt tillatte omgivelsestemperaturen i henhold til databladet.

Område A: Ising ved omgivelsestemperaturer ≤ 0 °C må forhindres

Område B: Kondens ved omgivelsestemperaturer > 0 °C må forhindres

På 30 hele dager, selvfølgelig fordelt utover året, er det ved en omgivelsestemperatur på ≤ 25 °C tillatt med en luftfuktighet på 95 %.

2961192

El-nr.: 4305019

<https://www.phoenixcontact.com/no/produkter/2961192>

Godkjenninger

🔗 To download certificates, visit the product detail page: <https://www.phoenixcontact.com/no/produkter/2961192>



cUL Recognized

Godkjennings-ID: FILE E 228652



UL Recognized

Godkjennings-ID: FILE E 228652



EAC

Godkjennings-ID: TR_TS_D_00573_c



UL Recognized

Godkjennings-ID: FILE E 228652



EAC

Godkjennings-ID: RU*C-DE.*08.B.00010



VDE Zeichengenehmigung

Godkjennings-ID: 40007758



VDE Zeichengenehmigung

Godkjennings-ID: 40048281



cUL Recognized

Godkjennings-ID: FILE E 228652



cUL Recognized

Godkjennings-ID: FILE E 172140



UL Recognized

Godkjennings-ID: FILE E 172140

REL-MR- 24DC/21-21 - Enkeltrelé



2961192

EI-nr.: 4305019

<https://www.phoenixcontact.com/no/produkter/2961192>

Klassifiseringer

ECLASS

ECLASS-11.0	27371601
ECLASS-12.0	27371601
ECLASS-13.0	27371601

ETIM

ETIM 9.0	EC001437
----------	----------

UNSPSC

UNSPSC 21.0	39122300
-------------	----------

REL-MR- 24DC/21-21 - Enkeltrelé



2961192

EI-nr.: 4305019

<https://www.phoenixcontact.com/no/produkter/2961192>

Environmental product compliance

China RoHS	Tidsrom for forskriftsmessig bruk: ubegrenset = EFUP-e
	Ingen farlige stoffer over grenseverdiene

REL-MR- 24DC/21-21 - Enkeltrelé

2961192

El-nr.: 4305019

<https://www.phoenixcontact.com/no/produkter/2961192>

Tilbehør

RIF-1-BPT/2X21 - Relesokkel

2900931

<https://www.phoenixcontact.com/no/produkter/2900931>



Relesokkel RIF-1..., for miniatyreffektrelé med en eller to vekselkontakter eller solid-state-relé med samme byggform, push-in-tilkobling, pluggmuligheter for inngangs-/støydempingsmoduler, monteres på NS 35/7,5

RIF-1-BSC/2X21 - Relesokkel

2900930

<https://www.phoenixcontact.com/no/produkter/2900930>



Relesokkel RIF-1..., for miniatyreffektrelé med en eller to vekselkontakter eller solid-state-relé med samme byggform, skrutilkobling, pluggmuligheter for inngangs-/støydempingsmoduler, monteres på NS 35/7,5

REL-MR- 24DC/21-21 - Enkeltrelé

2961192

El-nr.: 4305019

<https://www.phoenixcontact.com/no/produkter/2961192>



PLC-BPT- 24DC/21-21 - Relesokkel

2900283

<https://www.phoenixcontact.com/no/produkter/2900283>



14 mm PLC-basismodul med push-in-tilkobling, uten rele- eller solid-state-releutstyr, monteres på monteringskinne NS 35/7,5, to vekselkontakter, inngangsspenning 24 V DC

PLC-BSC- 24DC/21-21 - Relesokkel

2967015

<https://www.phoenixcontact.com/no/produkter/2967015>



14 mm PLC-basismodul med skrutilkobling, uten rele- eller solid-state-releutstyr, monteres på monteringskinne NS 35/7,5, to vekselkontakter, inngangsspenning 24 V DC

REL-MR- 24DC/21-21 - Enkeltrelé

2961192

El-nr.: 4305019

<https://www.phoenixcontact.com/no/produkter/2961192>



PLC-BPT- 24UC/21-21 - Relesokkel

2900284

<https://www.phoenixcontact.com/no/produkter/2900284>



14 mm PLC-basismodul med push-in-tilkobling, uten rele- eller solid-state-releutstyr, monteres på monteringskinne NS 35/7,5, to vekselkontakter, inngangsspenning 24 V AC/DC

PLC-BSC- 24UC/21-21 - Relesokkel

2967028

<https://www.phoenixcontact.com/no/produkter/2967028>



14 mm PLC-basismodul med skrutilkobling, uten rele- eller solid-state-releutstyr, monteres på monteringskinne NS 35/7,5, to vekselkontakter, inngangsspenning 24 V AC/DC

REL-MR- 24DC/21-21 - Enkeltrelé

2961192

El-nr.: 4305019

<https://www.phoenixcontact.com/no/produkter/2961192>



PLC-BSC- 24DC/ 1- 1/ACT - Relesokkel

2967057

<https://www.phoenixcontact.com/no/produkter/2967057>



14 mm PLC-basismodul for utgangsfunksjoner, med skrutilkobling, uten relé eller solid-state-releutstyr, monteres på monteringskinne NS 35/7,5, med lastreturledertilkobling (BB), to N/O (1-1), inngangsspenning 24 V DC

Phoenix Contact 2023 © - Alle rettigheter forbeholdt

<https://www.phoenixcontact.com>

PHOENIX CONTACT AS

Strømsveien 344

N-1081 Oslo

+47 22 07 68 00

norge@phoenixcontact.com