

article#	124-6
article description	CEE-wall mounted socket 32A 4p 6h IP44
description long	CEE-wall mounted socket 32A 4p 6h IP44 housing material: PA6 rated current: 32A number of poles: 4 (3P+PE) clock-position: 6h rated voltage/frequency: 380-415V~ / 50+60Hz contacts: brass connection technology: screw terminals cable entry: top and rear inc. threaded cable grommet IP protection class: IP44
GTIN (EAN)	9003399124068
country of origin	AT
customs number	85366990
net weight	0.291 kg
packaging quantity	10
minimum order quantity	10

ETIM 9.0	EC001321
Model	Surface mounted
IEC-amperage	32 A
Number of poles	4
Voltage according to EN 60309-2	400 V (50+60 Hz) red
Clock hour position	6 h
Identification colour	Red
Degree of protection (IP)	IP44
Connection system	Screwed terminal
Cable entry	Gland nut
Material	Plastic
Contact material	CuZn
Surface treatment contacts	Untreated
Type of fastening	Inner lying mounting

a	155 mm
b	106 mm
wire flexible	2,5-6 mm ²
wire solid	2,5-10 mm ²
contact screws	110 Ncm
housing screws	110 Ncm
dismantling length	50 mm
stripping length	12-14 mm
ambient temperature	-25 – 40 °C
temperature resistance	-25 – 80 °C

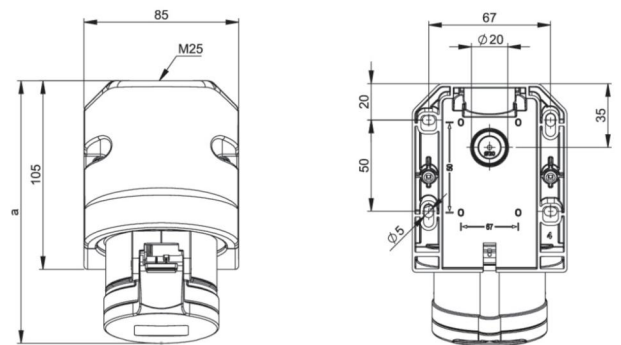

b=Höhe/height
Neigung/angle=15°



<https://www.pcelectric.at/shop/en/?func=detail&artnr=124-6>

