

MOSS

	~220-240V 50-60Hz		IP65				
--	----------------------	--	------	--	--	--	--

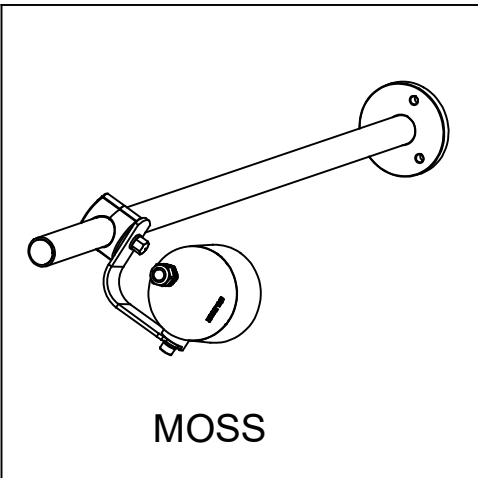

MOSS

ACCESSORY



hermetic box,
3-way
145ZX0009



connector
4701420002

DIN 7981 Ø4,2x60 		Ø8x50
x3	x3	x3

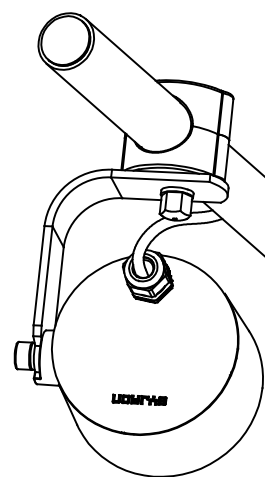
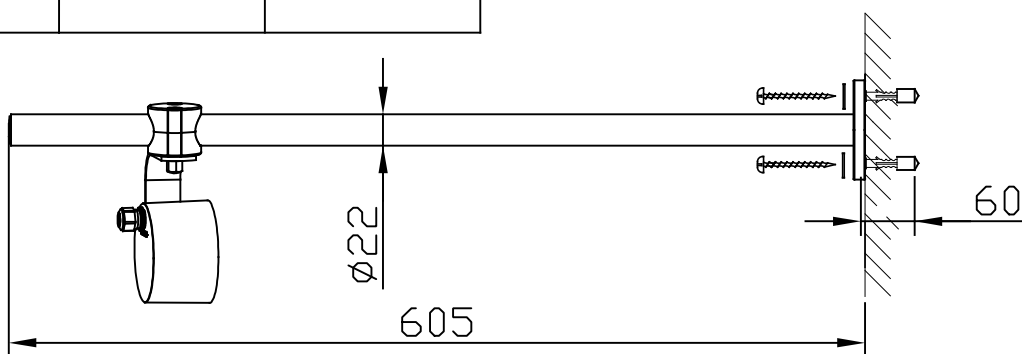

H05RN-F 3G1
L=3m



BOX
IP65,
400V, 16A

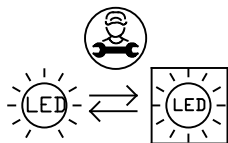
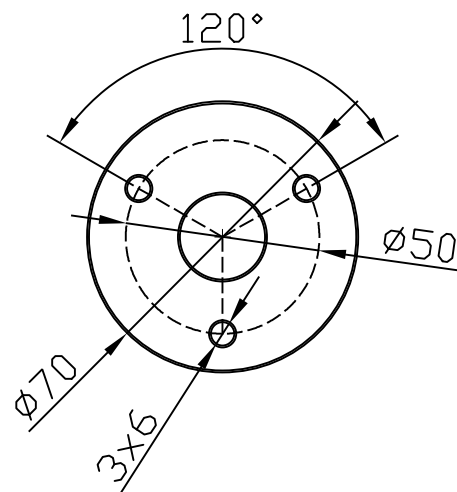

(PL) Moduł LED zintegrowany AC
Wymienne (tylko LED) źródło światła przez profesjonalny serwis

(ENG) LED module AC integrated
Replaceable (LED only) light source by a professional

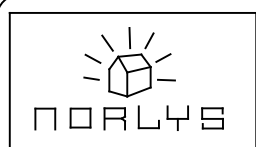



- (ENG) Assembly of the luminaire and replacement of the LED module contained in this luminaire shall only be done by the manufacturer or his service agent or a similar qualified person. Please respect local norms.
- (NOR) Installasjon skal utføres av en autorisert installatør/fagmann.
- (SWE) All installation skall utföras av auktoriserad elinstallatör.
- (DE) Die Montage und der Austausch der in dieser Leuchte enthaltenen Lichtquelle dürfen nur durch den Hersteller oder seinen Kundendienst oder eine gleich qualifizierte Person ausgeführt werden. Bitte lokale Bestimmungen beachten!
- (FR) Le montage et le remplacement de la source lumineuse du luminaire doit être fait uniquement par le fabricant, un agent de maintenance ou une personne ayant des qualifications similaires. Merci de respecter la réglementation nationale.
- (PL) Montaż oprawy oraz wymiana źródła światła zawarte w oprawie powinny być wymieniane wyłącznie przez producenta czy też przedstawiciela serwisu lub inną osobę wykwalifikowaną.



- (ENG) Risk of electric shock. Turn off the power before replacing the light source.
- (NOR) Fare for elektrisk støt. Skru av strømmen før skifte av lyskilde.
- (SWE) Risk för elektriska stötar. Koppla bort strömmen innan byte av ljuskälla sker.
- (DE) Gefahr eines elektrischen Schlags. Schalten Sie die Stromversorgung aus, bevor Sie die Lichtquelle austauschen.
- (FR) Risque d'électrocution. Éteindre le courant avant de remplacer la source lumineuse.
- (PL) Ryzyko porażenia prądem elektrycznym. Wyłącz zasilanie przed wymianą źródła światła.

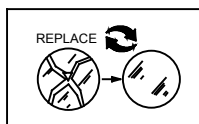

- (ENG) Replace any cracked protective screen.
- (NOR) Sprukket glass må skiftes
- (SWE) Sprucket glas måste bytas.
- (DE) Ersetzen Sie jeden beschädigten Schutzschirm.
- (FR) Remplacer les écrans de protection fissurés.
- (PL) Wymienić każdy pęknięty ekran ochronny.

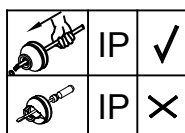

- (ENG) Only pierce NORLYS gasket with the installation cable of 6-10mm diameter. Damage caused by tools will lead to IP degradation. Wrong installation leads to loss of warranty.
- (NOR) Gjennombor NORLYS-pakning med installasjonskabel \varnothing 6-10 mm diameter. Skader forårsaket av verktøy vil føre til IP-nedbrytning. Feil installasjon fører til tap av garanti.
- (SWE) Använd endast 6-10mm \varnothing kabel för genomträngning av packningar. Skador orsakade av andra typer av verktyg kan sänka IP-klassning på armaturen. Felaktig installation kan orsaka garantiförlust.
- (DE) Nur NORLYS Dichtung mit dem Installationskabel eines Durchmessers von 6-10mm durchstechen. Beschädigung durch Werkzeuge führt zu IP Verminderung und Garantieverlust.
- (FR) Percez seulement le joint NORLYS avec le câble d'installation d'un diamètre de 6 à 10 mm. Les dommages causés par des outils entraîneront une dégradation de l'IP et la perte de garantie !
- (PL) Uszczelkę NORLYS \varnothing 6-10mm przebijać tylko przewodem instalacyjnym. Przebicie innymi narzędziami powoduje utratę szczelności IP.