

# BORNHOLM



~220-240V  
50-60Hz



IP65

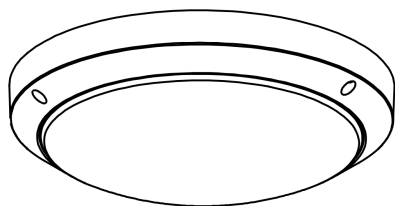
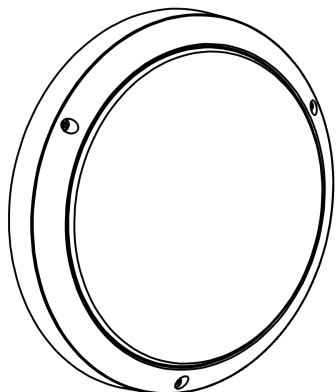
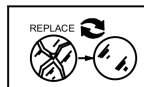

BORNHOLM

	IP	✓
	IP	✗

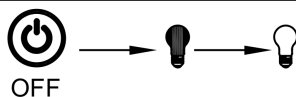
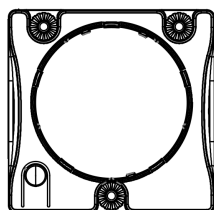
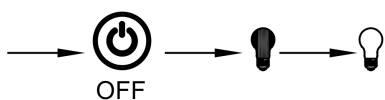
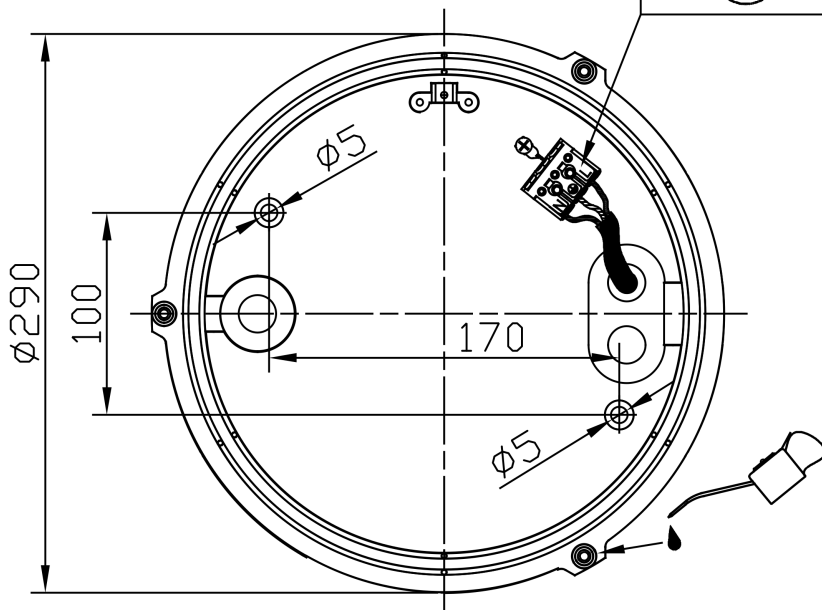

max.110mm  
A Ø55-Ø60

HALOGEN Max.46W

LED Max.9W

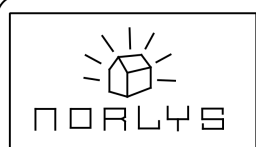
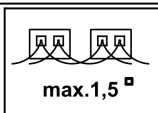
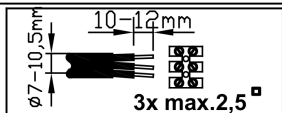
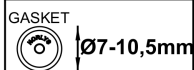



- (ENG) The light source contained in this luminaire shall only be replaced by the manufacturer or his service agent or a similar qualified person.
- (NOR) Installasjon skal utføres av en autorisert installatør/fagmann.
- (SWE) All installation skall utföras av auktoriserad elinstallatör.
- (DE) Die Montage und der Austausch der in dieser Leuchte enthaltenen Lichtquelle dürfen nur durch den Hersteller oder seinen Kundendienst oder eine gleich qualifizierte Person ausgeführt werden. Bitte lokale Bestimmungen beachten!
- (FR) Le montage et le remplacement de la source lumineuse du luminaire doit être fait uniquement par le fabricant, un agent de maintenance ou une personne ayant des qualifications similaires. Merci de respecter la réglementation nationale.
- (PL) Źródło światła zastosowane w tej oprawie oświetleniowej powinno być wymieniane wyłącznie przez producenta lub jego przedstawiciela serwisowego, lub podobnie wykwalifikowaną osobę.



- (ENG) Turn off the power before replacing the light source.
- (NOR) Skru av strømmen før skifte av lyskilde.
- (SWE) Koppla bort strömmen innan byte av ljuskälla sker.
- (DE) Schalten Sie die Stromversorgung aus, bevor Sie die Lichtquelle austauschen.
- (FR) Éteindre le courant avant de remplacer la source lumineuse.
- (PL) Wyłącz zasilanie przed wymianą źródła światła.

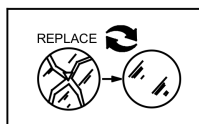

- (ENG) Replace any cracked protective screen.
- (NOR) Sprukket glass må skiftes
- (SWE) Sprucket glas måste bytas.
- (DE) Ersetzen Sie jeden beschädigten Schutzschirm.
- (FR) Remplacer les écrans de protection fissurés.
- (PL) Wymienić każdy pęknięty ekran ochronny.

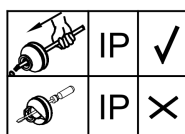

- (ENG) Only pierce NORLYS gasket with the installation cable of 7-10,5mm diameter. Damage caused by tools will lead to IP degradation. Wrong installation leads to loss of warranty.
- (NOR) Gjennombror NORLYS-pakning med installasjonskabel  $\varnothing$ 7-10,5 mm diameter. Skader forårsaket av verktøy vil føre til IP-nedbrytning. Feil installasjon fører til tap av garanti.
- (SWE) Använd endast 7-10,5mm  $\varnothing$  kabel för genomträngning av packningar. Skador orsakade av andra typer av verktyg kan sänka IP-klassning på armaturen. Felaktig installation kan orsaka garantiförlust.
- (DE) Nur NORLYS Dichtung mit dem Installationskabel eines Durchmessers von 7-10,5mm durchstechen.  
Beschädigung durch Werkzeuge führt zu IP Verminderung und Garantieverlust.
- (FR) Percez seulement le joint NORLYS avec le câble d'installation d'un diamètre de 7 à 10,5 mm. Les dommages causés par des outils entraîneront une dégradation de l'IP et la perte de garantie !
- (PL) Uszczelkę NORLYS  $\varnothing$ 7-10,5mm przebijać tylko przewodem instalacyjnym. Przebicie innymi narzędziami powoduje utratę szczelności IP oraz utratę gwarancji.