



**2430S**

**ERGO™ Spisstenger med isolert to-komponents håndtak. Fosfatert utførelse**



## PRODUKTDETALJER

- Isolerte to-komponents ERGO™ håndtak: termoplastisk overflate på robust polypropylene gir enestående grep
- Utviklet i henhold til den vitenskapelige ERGO™ prosessen
- For arbeid på strømførende utstyr opp til 1000 V i overensstemmelse med IEC60900
- Klippekapasitet: 2.5 mm til 3 mm Cu, 1.8 mm Fe, 1.4 mm til 1.6 mm Fe+
- Halvrunde riflede kjefter for godt grep på flate og runde materialer og god tilgjengelighet på trange plasser
- Rette kjefter med herdede skjær for klipping av myk og hard tråd
- Høykvalitets stål
- Fosfatert utførelse, rustbeskyttet
- Standard: ISO 5745, IEC 60900
- Hvert eneste verktøy er testet til 10.000V i 10 sekunder på slutten av produksjonssyklusen

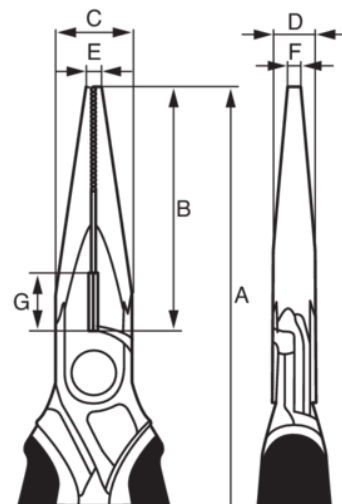





**Follow the Fish!**







PRODUKTEGENSKAPER





Produkt: **2430S-140**

<b>A</b>	140 mm	<b>B</b>	37 mm	<b>C</b>	15 mm
<b>D</b>	7,8 mm	<b>E</b>	2,5 mm	<b>F</b>	2 mm
<b>G</b>	12 mm	 2.5 mm	 1.8 mm		
 1.4 mm		 120 g			

Produkt: **2430 S-160**

<b>A</b>	160 mm	<b>B</b>	49 mm	<b>C</b>	16 mm
<b>D</b>	8 mm	<b>E</b>	3 mm	<b>F</b>	2.5 mm
<b>G</b>	12 mm	 3.0 mm	 1.8 mm		
 1.6 mm		 160 g			

Produkt: **2430 S-200**

<b>A</b>	200 mm	<b>B</b>	72 mm	<b>C</b>	17 mm
<b>D</b>	9 mm	<b>E</b>	4 mm	<b>F</b>	2.5 mm
<b>G</b>	12 mm	 3.0 mm	 1.8 mm		
 1.6 mm		 170 g			

