



2430G

ERGO™ Lange spisstenger med selvåpnende kjefter og to-komponents håndtak. Fosfatert utførelse



PRODUKTDETALJER



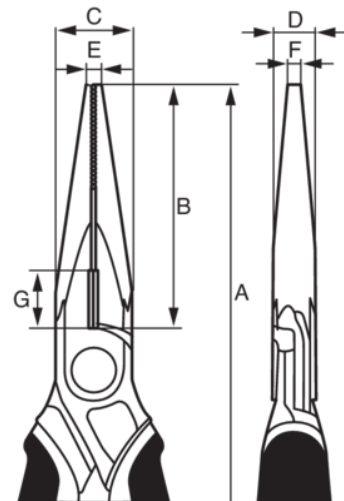

- To-komponents ERGO™ håndtak: myk termoplastisk overflate på robust polypropylene gir enestående grep
- Utviklet i henhold til den vitenskapelige ERGO™ prosessen
- Klippekapasitet: 2.5 mm til 3 mm Cu, 1.8 mm Fe, 1.4 mm til 1.6 mm Fe+
- Utstyrt med en patentert returfjær med på/av funksjon
- Halvrunde riflede kjefter for godt grep på flate og runde materialer og god tilgjengelighet på trange plasser
- Rette kjefter med herdede skjær for klipping i myk og hard tråd
- Høykvalitets stål
- Fosfatert utførelse, rustbeskyttet
- Standard: ISO 5745
- IP = Industripakk







Follow the Fish!







Produkt: 2430 G-140

A	140 mm	B	37 mm	C	15 mm
D	7,8 mm	E	2,5 mm	F	2 mm
G	12 mm	 2.5 mm	 1.8 mm		
 1.4 mm	 120 g				





Produkt: 2430 G-160

A	160 mm	B	51 mm	C	16,5 mm
D	8,8 mm	E	3 mm	F	2.5 mm
G	12 mm	 3.0 mm	 1.8 mm		
 1.6 mm	 160 g				





Produkt: 2430 G-200

A	200 mm	B	72 mm	C	17 mm
D	9,3 mm	E	3 mm	F	2.5 mm
G	12 mm	 3.0 mm	 1.8 mm		
 1.6 mm	 170 g				





Produkt: 2430 G-140 IP

A	140 mm	B	37 mm	C	15 mm
D	7,8 mm	E	2,5 mm	F	2 mm
G	12 mm	 2.5 mm	 1.8 mm		
 1.4 mm	 120 g				

Produkt: 2430 G-160 IP

A	160 mm	B	51 mm	C	16,5 mm
D	8,8 mm	E	3 mm	F	2.5 mm
G	12 mm	 3.0 mm	 1.8 mm		
 1.6 mm	 160 g				

Produkt: 2430 G-200 IP

A	200 mm	B	72 mm	C	17 mm
D	9,3 mm	E	3 mm	F	2.5 mm
G	12 mm	 3.0 mm	 1.8 mm		
 1.6 mm	 170 g				

