

ALPHA 400/630 DIN,
KIT F. INSTALL. MOUNTING DEVICE WITH ROW
DISTANCE 150 MM H=300 W=500

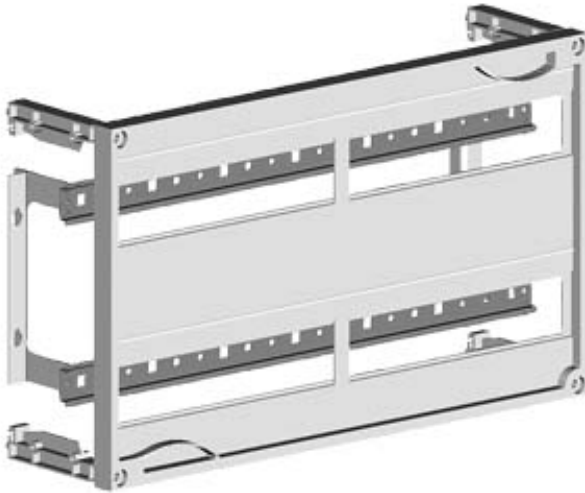

Similar to image

Technical data:

Accessories

others

Certificates/approvals:

General Product
Approval

Declaration of
Conformity

Test Certificates



GOST



EG-Konf.

[Type Test
Certificates/Test
Report](#)

Further information:

Information- and Downloadcenter (Catalogs, Brochures,...)

<http://www.siemens.com/lowvoltage/catalogs>

Industry Mall (Online ordering system)

<http://www.siemens.com/lowvoltage/mall>

Service&Support (Manuals, Certificates, Characteristics, FAQs,...)

<http://support.automation.siemens.com/WW/view/en/8GK4351-2KK22/all>

Image database (product images, 2D dimension drawings, 3D models, device circuit diagrams, ...)

http://www.automation.siemens.com/bilddb/cax_en.aspx?mlfb=8GK4351-2KK22

CAx-Online-Generator

<http://www.siemens.com/cax>

last change:

Mar 4, 2013