



ALPHA 630 DIN FLOOR-MOUNTED DB IP55,
SK I,
RAL 7035 H=1950 W=1050 D=320 INCL. BASE AND
SHEET STEEL DOOR W. CLOSED SIDE PANEL INCL. 2-K
FLANGES

Similar to image

Technical data:

Height	mm	1,950
Width	mm	1,050
Depth	mm	320
Protection class IP		IP55
Design of the cap/top cover		others
RAL color number		7035
Mounting depth	mm	320
Surface processing		powder-coated
Acceptability for application / for outside use		No
Material / of the enclosure		Steel
Product component / cable entry		Yes
Product component / Mounting plate		No
Product extension / optional / Sequence		No
Suitability for interaction / lightning protection		No

Certificates/approvals:

**General Product
Approval**

Test Certificates



[Type Test
Certificates/Test
Report](#)

Further information:

Information- and Downloadcenter (Catalogs, Brochures,...)

<http://www.siemens.com/lowvoltage/catalogs>

Industry Mall (Online ordering system)

<http://www.siemens.com/lowvoltage/mall>

Service&Support (Manuals, Certificates, Characteristics, FAQs,...)

<http://support.automation.siemens.com/WW/view/en/8GK1323-8KN44/all>

Image database (product images, 2D dimension drawings, 3D models, device circuit diagrams, ...)

http://www.automation.siemens.com/bilddb/cax_en.aspx?mlfb=8GK1323-8KN44

CAX-Online-Generator

<http://www.siemens.com/cax>

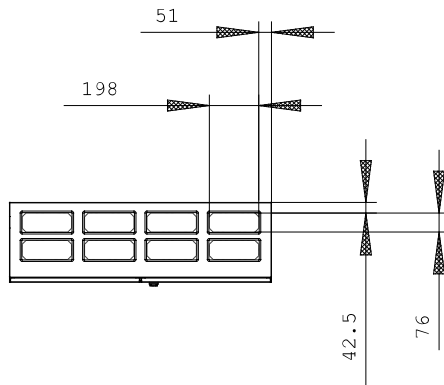
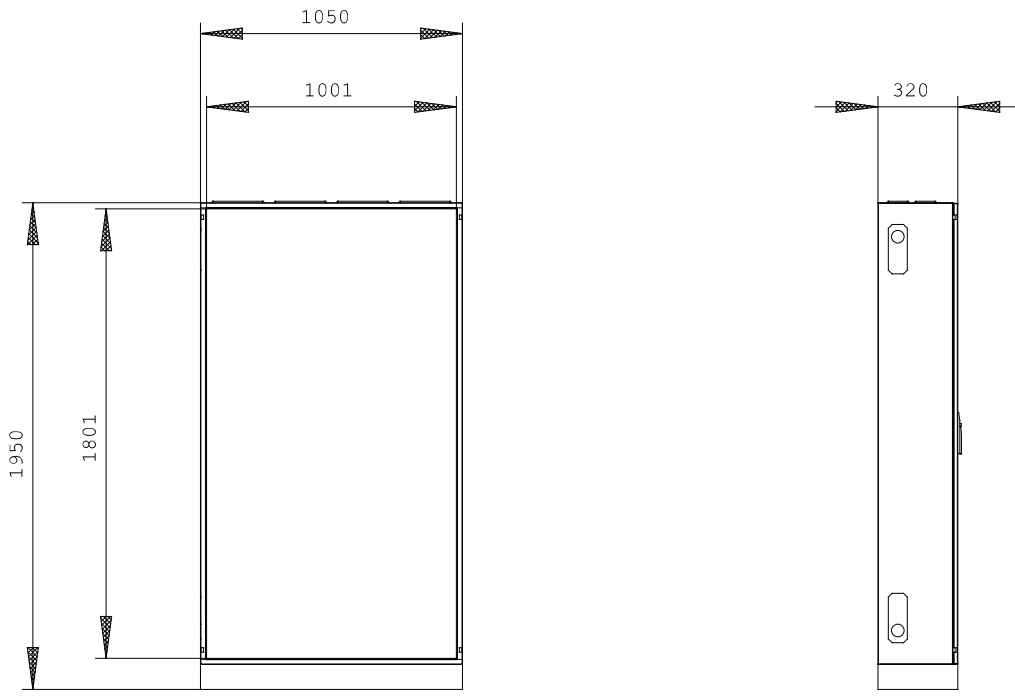

last change:

Oct 8, 2012