



Part no. : 13102

Plug PowerTOP Xtra

rubberised handle area,

highly heat-resistant contact carrier, frame terminals, nickel-plated contacts, cable gland and sealing, strain relief and protection against kinking, enclosure with thread lock, two safety slides

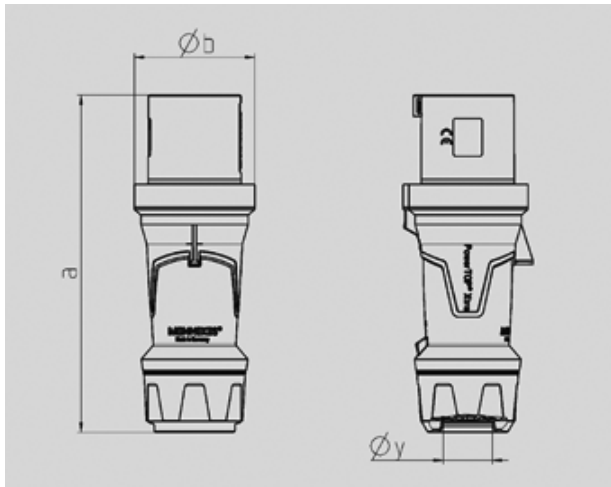

Drawing	Amp.	63		
		3	4	5
2 MB 226	Poles			
Dim. in mm	a	250	250	250
	b	90	90	90
	y	36	36	36
Terminal for cond. cross		6	6	6
section (mm ²) min.-max.		-16	-16	-16

 Article-group : **2215**

voltages : 230V

rated current : 63A







pole : 3 pole

IP protection types : 44

position of ground contact : 6h

weight : 0

PART NUMBERS

V	110V	230V	400V	500V	>50-500V	
Hz	50,60	50,60	50,60	50,60	100-300	300-500
colour						
amp.						
63 A	3	13101	13102			
	4	13105	13106	13107		
	5	13111	13112			