



Part no. : 14205

Connector PowerTOP Xtra

rubberised handle area,
with SoftCONTACT,

highly heat-resistant contact carrier, frame terminals, cable gland and sealing, strain relief and protection against kinking, enclosure with thread lock, two safety slides

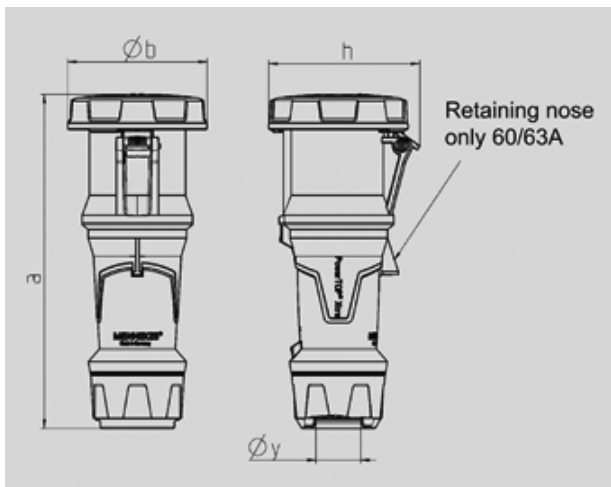

Drawing 3 MB 68	Amp. Poles	63			125		
		3	4	5	3	4	5
Dim. in mm	a	270	270	270	310	310	310
	b	113	113	113	125	125	125
	h	123	123	123	135	135	135
	y	36	36	36	49	49	49
Terminal for cond. cross		6	6	6	25	25	25
section (mm ²) min.-max.		-16	-16	-16	-50	-50	-50

 Article-group : **3216**

voltages : 230V

rated current : 63A







pole : 4 pole

IP protection types : 67

position of ground contact : 9h

weight : 0

PART NUMBERS

	V	110V	230V	400V	500V	>50-500V	
	Hz	50,60	50,60	50,60	50,60	100-300	300-500
	colour						
	amp.						
63 A	3	14201	14202	14203			
	4	14204	14205	14206	14207	14208	14209
	5	14210	14211	14212	14213		14214
125 A	3	14215	14216				
	4	14217	14218	14219	14220		
	5	14223	14224	14225	14226		14227