

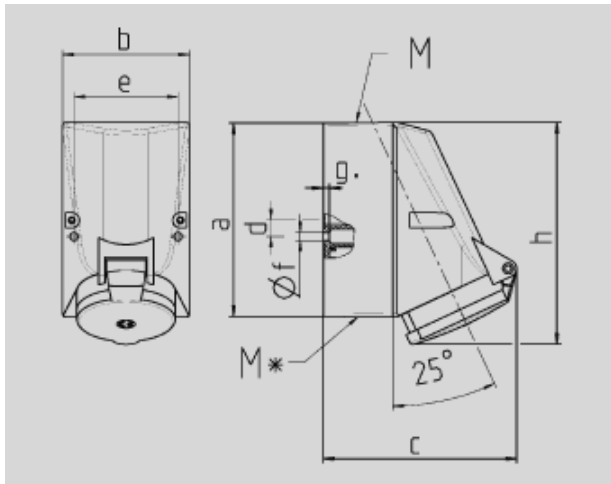

Part no. : 1424

Receptacle

internal fixing, 1 cable entry at top, two blind cable entries (can be cut out)
 at the bottom, enclosure can be turned 180°, with 5 blind holes for mounting
 special terminals if required



Drawing	Amp.	16		32				
		Poles		4	5	3	4	5
1 MB 43								
Dim. in mm	a	128	128	128	128	128		
	b	84	84	84	84	84		
	c	122	124	136	136	138		
	d	11	11	11	11	11		
	e	68	68	68	68	68		
	f	5,3	5,3	5,3	5,3	5,3		
	g	4	4	4	4	4		
	h	144	145	158	158	160		
	M	25	25	32	32	32		
	M*	2x25 (blind) to be cut out		2x25 (blind) to be cut out				
	Max. cable diam. (mm)	18	18	18/25	18/25	18/25		
	Terminal for cond. cross section (mm ²) min.-max.	1,5	1,5	2,5	2,5	2,5		
		-4	-4	-10	-10	-10		

 Article-group : **1041**

voltages : 230V

rated current : 32A

pole : 4 pole







IP protection types : IP44

position of ground contact : 9h

packing unit : 0010

weight : 370 g

PART NUMBERS

	V	110V	230V	400V	500V	>50-500V	
	Hz	50,60	50,60	50,60	50,60	100-300	300-500
	colour						
	amp.						
16 A	4	3030	3034	1418	3032	3035	3028
	5	3041	3045	1419	3043	3046	3039
32 A	3	1420	1421	1422		3139	3134
	4	1423	<u>1424</u>	1425	1426	1427	1428
	5	1555	1556	1557	3152	3154	3149