

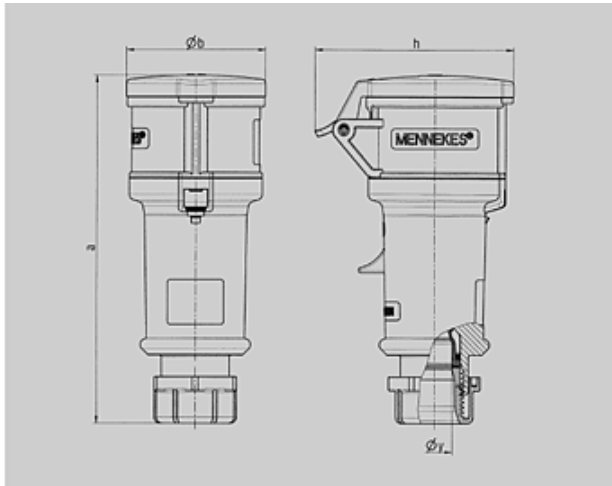

Part no. : 125

Connector ProTOP

with cable gland with integral protection against kinking. Front and cover fitted with thread lock and safety slide.



Drawing	Amp.	16			32	
		3 MB 60 Poles			5	
Dim. in mm	a	160	174	172	210	
	b	57	61	69	80	
	h	83	92	98	108	
	y	16	16	16	22	
Terminal for cond. cross section (mm ²) min.-max.		1	1	1	2,5	
		-2,5	-2,5	-2,5	-6	

 Article-group : **3197**

voltages : 230V

rated current : 32A

pole : 4 pole







IP protection types : IP44

position of ground contact : 9h

packing unit : 0010

weight : 332 g

PART NUMBERS

	V	110V	230V	400V	500V	>50-500V	
		Hz	50,60	50,60	50,60	50,60	100-300
	colour						
	amp.						
16 A	3	179A	180A	181A	201		
	4	202	193A	194A	195A	308	309
	5		199A	15A	310	312	313
32 A	3	121	122				
	4		<u>125</u>	126	127	314	
	5		645	16A	646		