

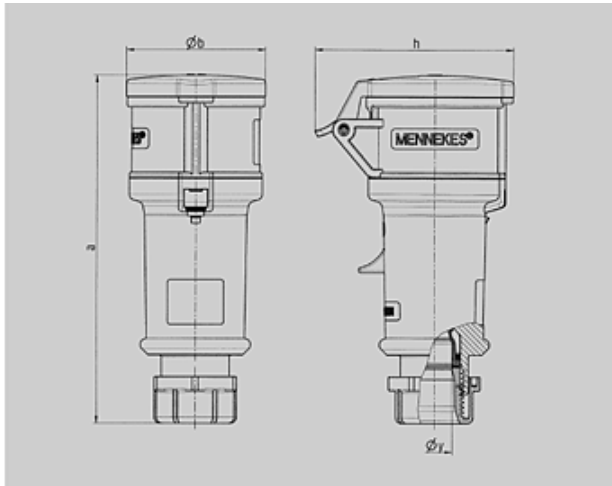

Part no. : 193A

**Connector ProTOP**

with cable gland with integral protection against kinking. Front and cover fitted with thread lock and safety slide.



Drawing	Amp.	16			32	
		3 MB 60 Poles			3	4
Dim. in mm	a	160	174	172	210	
	b	57	61	69	80	
	h	83	92	98	108	
	y	16	16	16	22	
Terminal for cond. cross section (mm <sup>2</sup> ) min.-max.		1	1	1	2,5	
		-2,5	-2,5	-2,5	-6	

 Article-group : **3197**

voltages : 230V

rated current : 16A

pole : 4 pole







IP protection types : 44

position of ground contact : 9h

packing unit : 0010

weight : 213 g

**PART NUMBERS**

	V	<b>110V</b>	<b>230V</b>	<b>400V</b>	<b>500V</b>	<b>&gt;50-500V</b>	
		Hz	50,60	50,60	50,60	50,60	100-300
	colour						
	amp.						
<b>16 A</b>	3	179A	180A	181A	201		
	4	202	193A	194A	195A	308	309
	5		199A	15A	310	312	313
<b>32 A</b>	3	121	122				
	4		125	126	127	314	
	5		645	16A	646		